

Università degli Studi di Padova
Facoltà di Ingegneria, Dipartimento di Ingegneria industriale
Laurea Magistrale in Ingegneria Energetica

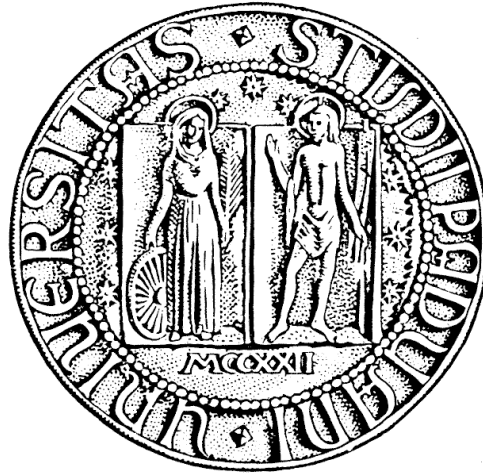

DEMAND CONTROLLED VENTILATION CASE STUDY ON COMFORT AND ENERGY

Relatore:

Ch.mo Prof. Michele De Carli (Università di Padova)

Correlatori:

Ing. Petra Vladykova Ph.D (Swegon AB)

Arch. Markus Kalo M.Sc (Swegon AB)

Dennis Johansson Ph.D (Università di Lund)

Laureando: Francesco Errico

Anno Accademico 2013/2014

1 Acknowledgements

I would like to express my deepest appreciation to all those who provided me the possibility to complete this report. To my supervisors: Prof. Michele De Carli, Ing. Petra Vladykova, Arch. Markus Kalo and Dennis Johansson for have shared their precious time and knowledge, for the useful comments, remarks and engagement through the learning process of this master thesis, as well as for the support on the way . I would like to thanks them for the patience as well. Furthermore I would like to thanks all the people I have been in touch in Swegon, in particular Börje Lehrman and John Woollett for their advices and all the other people placed in both Gothenburg and Stockholm offices for their help, support and kindness. I would also thank the overall Engelsons management to have given me the opportunity to study the building and to have shared their knowledge with me. Another though and thank is due to my good friend Chenée who corrected the English through the entire thesis despite her working tasks.

Special thanks go to my family. Words cannot express how grateful I am to my mother Rita and my father Dario who, with their sacrifices, gave me the possibility to reach this target. I will never forget it and I hope that one day I will be able to repay it. Thanks also to my brother, one of mine sustains, I can feel he is by my side supporting me along my path. A genuine and special thanks to Silvia, without her probably all this never happened; you gave me the trust, support and energy to begin this master course, sustaining me during the way and during my period abroad and the entire duration of this project with patient, trust and enthusiasm.

One more though for all my friends, my historical flat mates, my Lonigo and Padua friends, with you I have shared a lot, life, separations and reconciliations, delights and sorrows, all that is friendship and with you and with all the experiences we did together I become the person I am now.

2 Contents

1	Acknowledgements	I
2	Contents	III
3	Abstract	1
4	Introduction	3
4.1	Demand controlled ventilation (DCV)	3
4.2	Objectives of the thesis	6
4.3	Methods and main findings	7
5	Survey of Engelsons in Falkenberg (office-retail solution)	9
5.1	Building description	9
5.2	Sub-system and zones.....	9
5.2.1	<i>Ventilation</i>	11
5.2.2	<i>Night mode</i>	11
5.2.3	<i>HVAC production</i>	12
6	Monitoring	13
6.1	Monitored data	13
6.1.1	<i>Indoor Environmental Data (IED)</i>	13
6.1.2	<i>Air Handling Unit Data (AHUD)</i>	14
6.1.3	<i>Weather data</i>	14
6.2	Availability of data	14
6.2.1	<i>IED - monthly percentage of available data for temperature</i>	14
6.2.2	<i>AHUD – monthly percentage of available data for temperature and airflow</i>	15
6.3	Data compatibility	15
6.3.1	<i>Quantity compatibility</i>	15
6.3.2	<i>Quality compatibility</i>	15
6.4	Detailed evaluation.....	16
6.4.1	<i>IED</i>	16
6.4.2	<i>AHUD</i>	16
6.4.2.1	<i>Temperature</i>	17
6.4.2.2	<i>Airflow</i>	17
6.4.2.3	<i>Night mode</i>	18
6.5	Constructing of a Reference Year on Records (RYR).....	19
6.5.1	<i>Quantity of records available</i>	19
6.5.2	<i>Compatibility of AHUD data and completion process</i>	20
6.5.3	<i>Coherence with outdoor temperature</i>	21
6.5.4	<i>Completed Reference Year on Records</i>	21

7	Environmental evaluation.....	23
7.1.1	<i>Indoor temperature during critical outdoor periods.....</i>	23
7.1.2	<i>Long period Comfort.....</i>	25
8	Estimated energy consumption based on thermal capacity and power	31
8.1	Thermal Capacity	31
8.2	Energy evaluation	35
8.3	Building classification	38
8.3.1	<i>Relative humidity classification.....</i>	39
8.3.2	<i>Energy Classification</i>	40
8.4	Conclusions on energy evaluation and building classification	41
9	IDA ICE modelling	43
9.1.1	<i>IDA ICE – software description.....</i>	43
9.1.2	<i>Model description.....</i>	43
9.1.3	<i>Result and verification of the model</i>	48
9.1.3.1	<i>Verification of the standard Weather (IWEC2 data)</i>	51
10	Energy evaluation	53
10.1	Scenario - CAV	53
10.2	Scenario - VAV.....	55
10.3	Scenario – DCV	56
10.4	Scenario – DCV class I	57
10.5	Sequence and comparative analysis	58
10.5.1	<i>Detailed energy analysis.....</i>	59
11	Economic evaluation	63
11.1	System cost.....	63
11.2	Operating cost.....	64
11.2.1	<i>Energy price.....</i>	65
11.2.2	<i>Operating cost with installed HP.....</i>	66
11.2.3	<i>Operating cost in scenario (DH-CH).....</i>	66
11.2.4	<i>Operating cost, comparison between installed HP and scenario (DH-CH).....</i>	68
11.3	Payback period	69
11.3.1	<i>Payback period with installed HP</i>	69
11.3.2	<i>Payback period in scenario (DH-CH)</i>	70
11.3.3	<i>Payback period, comparison between real installed HP and scenario (DH-CH)</i>	71
12	Discussion and conclusion.....	73

13 Appendix A.....	77
13.1 Appendix A.1: Measurements and probes	77
13.2 Appendix A.2: Building documentation and HVAC sketch	79
13.3 Appendix A.3: Reference tables.....	82
13.4 Appendix A.4: Detailed results	84
14 Bibliography.....	121
15 Symbols and abbreviations	123

3 Abstract

The purpose of a heating, ventilation and air conditioning system is to provide the best indoor environmental conditions in terms of temperature and relative humidity while employing as little energy as possible. From here comes the importance to monitor constantly the indoor environmental parameters such as temperature and relative humidity and the energy supplied by the production and ventilation system that has to be the most efficient, as far as possible. One of the methods to compare the efficiency of different ventilation systems is to make dynamic simulations with the aid of advanced software.

The objectives of this research were to verify the operation of an installed system and to show the importance of a continuous monitoring of a facility installed in the south of Sweden and to compare the energy saving achievable with different ventilation systems with focus on keeping or improving the indoor comfort condition. The systems taken into account were: a constant air volume, a variable air volume and a demand controlled ventilation system, or rather, the three main evolutions of a heating, ventilation and air conditioning system. The energy saving was also analysed considering two different production scenarios in order to make the evaluation in terms of purchased energy after that an economical assessment was evaluated. The findings show the importance of continuous monitoring, the advantages of the choice of an advanced ventilation system and the weight that the production system has in the energy and economical cost. The results also help to understand the importance of indoor comfort analysis and its effect on energy consumption and people.

Keywords

Case study, energy and buildings, demand controlled ventilation (DCV), constant air volume (CAV), variable air volume (VAV), indoor environmental quality (IEQ), long period comfort (LPC), monitoring system, HVAC, IDA ICE, dynamic simulation, multifunctional building, air handling unit (AHU), reference year on records (RYR)

4 Introduction

More and more human beings are changing their life habits and adapting their work performance and life styles, and in a certain way evolving their uses in life style and comfort, but what cannot change

is a need for fresh air and comfort to ensure a healthy and good life quality. People tend to forget it because they begin breathing when they are born and it is an automatism. In order to exist an average person needs 1 kg of food, 2 kg of liquids and 15 kg of air per day. In addition, people spend up to 90% of their time indoors (Sundell, et al., 1994). Because of that, to ensure people's health and comfort when they are indoors, the indoor air quality and thermal comfort must be appropriate. An indoor climate system serves this purpose (Bra Ventilation, 2003); (Nilsson, 2003); (Goodfellow, et al., 2001).

The indoor climate system must also use as little resource as possible, where energy is one type of resource (Johansson, 2005). To minimise energy consumption, technology in the ventilation industry evolves over the years upgrading the HVAC systems from the constant air volume (CAV) to variable air volume (VAV) to its sub group called demand controlled ventilation (DCV). From a system that handles continuously the whole air volume (CAV) to a system that handles the strictly demanded air volume (DCV). In other words, this evolution adapts the HVAC system to the people who occupy the building.

Equally important is the monitoring of the ventilation system and of the building. An appropriate monitoring system can provide information about the right functioning of the HVAC system in order to reduce the extra energy used during operation. The purpose of an indoor climate system is to ensure internal comfort for people, because of that, there is not the possibility to reduce the energy used if this reduction goes to affect the indoor comfort conditions.

For this reason, a monitoring system is important because it is seen as the facility that allows the linkage between the best indoor conditions and minimum energy usage.

4.1 Demand controlled ventilation (DCV)

What is a demand controlled ventilation system

Before proceeding with the analysis of the recorded data and with the modelling of the systems it is appropriate to give a brief overview of the characteristics of a demand controlled ventilation system.

A demand controlled ventilation system (DCV) is a sub category of a HVAC system that must ensure a good indoor air quality and both thermal and acoustic comfort inside a building.

At the state of the knowledge, a generic HVAC system can be categorized into two types:

- **constant air volume (CAV)** - ventilation with constant airflow. This type of ventilation system is characterized by one or two manual operations (e.g. ON/OFF), chronological management or control of supply/extract temperature;
- **variable air volume (VAV)**, in this case the control is managed in a manual or continuous mode with prefixed models or time steps.

A variable air volume system with automatic control based on the real need, that automatically adapts the supply air temperature, and supply airflow to keep the target conditions inside a building is defined as **demand controlled ventilation (DCV)**.

In other words, a DCV system is designed with the aim of supply a quantity of fresh air fitted with the need in every situation, ensuring the right quantity of fresh airflow and right environmental conditions in terms of relative humidity and temperature.

Because of that the parameters that could control a DCV system are of course temperature and relative humidity, but also carbon dioxide (CO₂) or volatile organic compound (VOC) that can accurately describe the quantity of occupants in a building or the pollution emitted by new furniture or manufacturing inside a building. This solution ensures that there is always the right indoor air quality.

If one considers a generic building and a DCV system designed for the control of the right indoor temperature set point, the difference between a DCV system and a CAV system can be displayed as in Figure 1. The area included in the rectangle defined by the blue line represents the cooling energy with a CAV ventilation system, the area with blue horizontal stripes represents the energy used with a DCV system and consequently the difference between the two areas (the red vertical stripes) the energy saved using a DCV system instead of a CAV system.

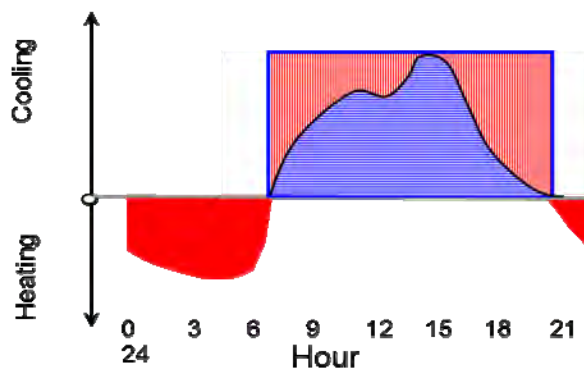

Figure 1 – Example of difference in energy use for heating and cooling between CAV and DCV systems (De Carli, M, 2012)

The same considerations can be done for both the heating and cooling periods.

As said above, a DCV system also has the potential to change the air volume coherently with the need. Figure 2 displays an example for that, even here for a hypothetic building, for the reduction in the supplied fresh air volume using a DCV ventilation system (which adapts the quantity of air to the people inside a building) and a CAV ventilation that always maintains the same quantity of air if the building is occupied or not.

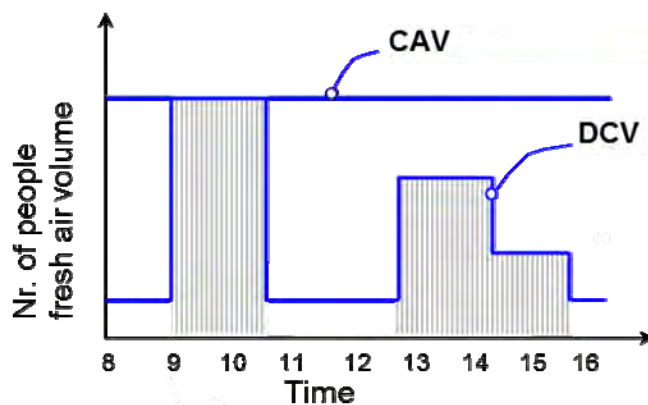

Figure 2 - Example of quantity of supplied fresh air between CAV and DCV systems (De Carli, M, 2012)

In this perspective it is easy to assume that a DCV ventilation system could be profitable compared to a CAV system in terms of energy for heating, cooling and ventilation.

Because of that the advantages of a DCV ventilation system are:

- Creates the best indoor comfort conditions for people who work / live inside a facility;

- Increases the comfort and the wellness with minimal energy used for heating, cooling and ventilation.

A DCV system can be installed in several places, the higher the occupancy and the fluctuation of the internal loads, the more profitable it is to use a DCV system instead of a standard CAV or VAV ventilation system.

For example, if a room is full a DCV system can handle the designated amount of air; alternatively, if the same room is empty a DCV system guarantees the hygienic airflow (different from country to country and defined by the local legislation). In addition, when the room is empty the operative temperature

can be moved from the optimum set point (e.g. in winter time it could be reduced by one or two degrees) increasing the energy saved. This operation is totally automatic.

Examples for applications are:

- Conference room, auditorium, theatres or cinemas;
- Offices;
- Restaurants;
- Schools, etc.

In all applications, it is fundamental to understand the purpose of the ventilation system, for example it has to be defined in the first step of design if the aim is to remove the contamination due to manufacturing inside a building or if the need is to keep the correct thermal comfort or both of them. With this decision it is important to understand the parameters to monitor for obtaining the desired target. The monitoring and the choice of the sensors is fundamental for the correct functioning of the system, in fact, because a DCV system adapts its functioning to the indoor conditions such as occupancy, temperature, etc... the sensors must be placed in the correct place and they must communicate with the central “brain”, a building management system (BMS). The fast and accurate communication is fundamental for the right functioning of the system because of the definition of the DCV system as a system that has to follow the load profile of a building and, because of that, it has to respond precisely and rapidly to the indoor changing.

The holistic approach

When defining why the communication and the regulation are so important it is necessary to state that the control is made in the rooms and the BMS and the air handling unit (AHU) and/or production elements are on a central level. Because of that, the overall system must be designed with a holistic approach that must take into account the entire ventilation system and the building.

In the common technical design, the entire system is divided into three levels such as:

- **System level:** comprehends all the production elements (e.g. AHU, heat pump ...) and the main electronic system management. All the equipment installed in the system level must be connected to the BMS system.
- **Zone level:** zones can be characterized by different set points, airflow and/or different occupancy.
This is important because of the presence of zone dampers, the airflow can be handled following the needs and also because, when possible, moved from zone to zone. All the zone dampers must be connected to the BMS system.
More zones are created, the control of the indoor air quality (IAQ) need to be more precise, increasing the indoor comfort but at the same time also increasing the purchasing and installation costs.
- **Room level:** here active diffusers/dampers can be found that make it possible to have an individual regulation increasing the comfort sensation. Active diffusers usually also include the monitoring system in order to have the most accurate regulation in temperature and airflow while everything is connected to the BMS system.

All these levels must be strictly linked with the target building. It is fundamental to know the use of the building because the overall HVAC system (included diffusers, monitors, etc...) must be designed taking into account what happens inside. Because of this, a thorough study of the energy consumption and the activity inside the building must be developed first.

Another important point in a DCV system is that using zone dampers for the variation of the airflow, also the pressure inside the ducts changes continuously keeping it constant at the central level. The pressure variations could lead to noise and draft. Because of that there is the need for a precise choice and design of zone dampers and active diffusers. Diffusers that must ensure at room level a stable movement of the airflow, having a good control of the airflow especially with low air volume. Because there is low air volume inside the ducts, there is the need for good thermal insulation in order to avoid thermal losses or undesired temperature rises.

All these considerations show the necessity of a holistic approach at system, zone and room level that must be done by experts in the ventilation field who have a deep knowledge of the system and targets.

Economic considerations

Because of all the previous descriptions, if the design is correct than DCV system is the right choice for the considered building. DVC system shows high potential in the energy saving that lead also to an economic saving that can strongly depend on the kind of building and the activity inside it. Of course the investment costs increase because of the use of high technology products and control, but because of the possibility of moving the airflow where needed there is the possibility to decrease the size of the air handling unit (AHU), risers and ducts. That means a reduction in the purchasing and installation costs for those elements. In addition this size reduction leads to a reduction of technical rooms and spaces used for ducts and risers as well, in other words, space that could be used differently (e.g. one more room in a hotel).

However, it is always important to make a detailed economic analysis taking into account the energy consumption history and the destination of the building.

Advantages of a DCV system

In summary, the advantages of a DCV system are:

- Reduction in the handled air volume;
- Smaller technical rooms and risers;
- Energy saving;
- Higher comfort;
- Individual regulation;
- Flexibility in the building;

This research has the aim to verify some of the described points through the use of analysis of recorded data and advanced computer simulations (De Carli, M, 2012), (Kalo, Markus T., 2013).

4.2 Objectives of the thesis

This master thesis work is sponsored by Swegon AB, which allows the study of a HVAC installation in one building (case study of multi-functional building of Engelsons in Falkenberg in Sweden used as office, retail with packing and a warehouse), which will be discussed and described below, constantly monitored in the indoor environmental quality and in the functioning.

The aim of the work is described as:

- Verify the parameters of the HVAC system installed in a building with attention to the indoor environmental quality (IEQ) with focus on temperature and relative humidity, and energy required for that purpose;
- Evaluate the advantages of DCV system in respect to a CAV solution with means of advanced simulation software (IDA ICE), upgrading (CAV → DCV) the system installed in an analysed building;
- Evaluate the energy saving and the consequent economic advantages due to evaluation of the payback time of the different solutions.

4.3 Methods and main findings

The monitored and studied area is a multi-functional area used as office and retail with packing. This facility was continuously monitored for three years collecting data about temperature, relative humidity and airflow in several rooms and ducts. Due to this monitoring and based on European Standards the indoor comfort conditions and the energy and humidity classification were evaluated. In addition, built an ideal year, based on the recorded temperature over the coils, the energy consumption for the monitored zone was evaluated.

Later, with means of dynamic simulation software (IDA ICE), three ventilation systems were simulated: constant air volume (CAV), variable air volume (VAV) and demand controlled ventilation (DCV) system. From these models, the energy used by the different ventilation systems to keep the indoor temperature set points was evaluated.

Comparing the different ventilation systems the achievable energy savings were evaluated, adopting one ventilation system instead of the other. For the economic evaluation it is essential to take into account the energy production system. Because of that, two production panoramas were considered: the real installed system constituted by a double effect ground coupled heat pump, and a frequent Swedish scenario such as district heating and chiller. Based on the price of the different electric and district heating sources for every ventilation system the annual operating cost was evaluated and consequently the achievable economic saving in hypothetical ventilation system improvements. The extra investment in each upgrade was also evaluated and because of the knowledge of the extra investment and the annual economic saving, the payback period for each system improvement scenario was determined.

The payback periods, evaluated for the different improvements, show in every analysed hypothesis the convenience of using the most advanced system instead of the older one. The advantage seems much more profitable as the production system is inefficient. In addition, the continuous monitoring of a building seems to be fundamental in the energy evaluations and in the achievement of the best indoor comfort conditions with the use of the smallest quantity of energy. Moreover, the analysis of the indoor comfort leads to think about the necessity of more elasticity in the evaluation of the comfort in the different word locations.

As a result, the overall project could be considered split in two parts: the first includes the evaluations directly connected with the monitoring, and the second block focusing on the modelling and the system improvement simulations.

Table 1 demonstrates the logical map for the entire work performed in the study.

Table 1 – Logical map of the project

Chapter	Main steps
(a) Survey and Monitoring	<ol style="list-style-type: none"> 1. Survey 2. Collecting data (AHU, environmental, weather) 3. Hourly sorting, coupling, completing 4. Data evaluation 5. Build of the RYR
(b) Environmental Evaluation	<ol style="list-style-type: none"> 6. Critical periods 7. Long Period Comfort
(c) Energy and Thermal Capacity	<ol style="list-style-type: none"> 8. Thermal capacity and electric power 9. Energy evaluation
(d) IDA ICE Modelling	<ol style="list-style-type: none"> 10. Model validation 11. Model improvement 12. CAV, VAV, DCV, DCV class I
(e) Energy Evaluation	<ol style="list-style-type: none"> 13. Energy saving
(f) Economic Evaluation	<ol style="list-style-type: none"> 14. Economic saving 15. Payback period

5 Survey of Engelsons in Falkenberg (office-retail solution)

5.1 Building description

The Engelsons building in Falkenberg (Sweden) was built in 2009 (in Figure 3). It is used as an office, retail with a packing area and a warehouse, and it could be considered as a multi-functional building with the indoor climate conditions controlled by a hybrid ventilation system consisting of air and water. In this system, there are two methods of ventilation and heating/cooling: firstly with air diffusers with constant airflow and secondly with climate beams with constant volume on the air side and variable on the water side.



Figure 3 - Building Engelsons in Falkenberg (view from South-East)

The building envelope is made of steel and concrete, all insulated in order to reduce the thermal losses. Table 2 shows the main information regarding the building envelope characteristics as used for design of HVAC system. Unfortunately, more detailed information about the walls' layers of the envelope is not available.

Table 2 – Overview of main buildings' characteristics

Building		
Floor surface	2 203 m ²	
Number of storeys	2	
Height of each storey	3,8 m	
Building envelope's materials	Steel and concrete	
Property	U-value [W/(m.K)]	Surface [m²]
Walls	0,315	1 483
Floor	0,146	2 203
Ceiling	0,193	2 203
Windows	1,2	106

5.2 Sub-system and zones

The building system can be split into three sub-systems where each sub-system is characterized by an air handling unit (TA/FA1, TA/FA2, and TA/FA3 respectively) serving a specific zone. TA/FA1 serves a warehouse zone and TA/FA3 for a rented office zone. TA/FA2 is the only monitored air handling unit and it serves as an office zone, a retail zone and a packing area zone.

- All of the office areas are heated and cooled by climate beams. In the common areas (corridors and such) air diffusers with constant airflow are installed.
- The retail is heated by air diffusers with constant airflow and cooled by central air installed when the building was built. There were also fan coils installed in later years.
- The packing area is air heated via air diffusers and cooled with an active beam above the work desk. Furthermore, in this packing area, a split system was later installed to compensate the heat peaks during summer and during winter time additional fan coils are turned on to satisfy the thermal balance and reach the indoor set temperature.
- The warehouse is heated only with air diffusers specially designed for large spaces.

Figure 4 represents the building's zones divided by the different air handling units.



Figure 4 – Ground floor and first floor

The monitored zones, office, retail and packing are served by the same AHU (TA/FA2) but the system to provide ventilation and heating/cooling are different for each one. Figure 5 is a diagram explaining the sub systems and zone divisions.

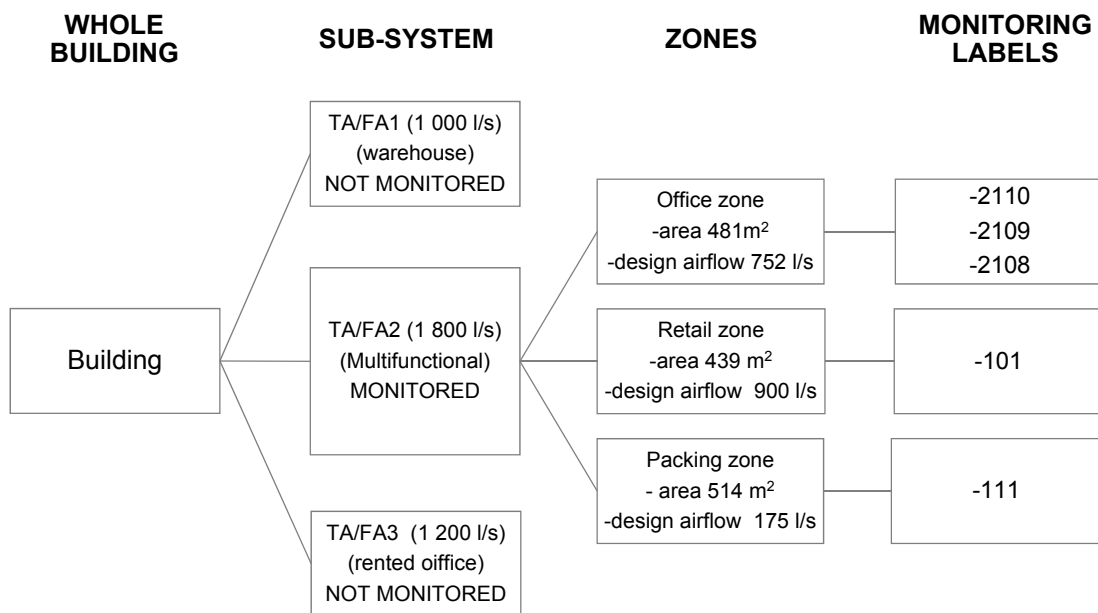

Figure 5 – Building split in sub-systems and zones

Note: in the initial design the packing zone was assigned as stock house with design airflow value of 0,35 l/(s·m²) as required by Swedish building regulation (Boverket, 2011). After sometime, this space was used as a working place and because of that, the airflow was increased by an additional 300 l/s. No temperature control was provided, resulting in extra fan coil heaters and extra cooler later being installed in the packing zone.

5.2.1 Ventilation

The ventilation system is a constant air volume system (CAV) and in some large rooms, there is the possibility of manually boosting airflow to increase the amount of air supplied. This function allows the system to be defined as a variable air volume system (VAV). Even if there is this option, the boost is never used as it can be seen further in the data analysis. Because of this, the system is considered as CAV system.

Each AHU is equipped with high efficiency rotary heat recovery, which allows pre-heating of the fresh air with exhausted air (referring to the winter time). The airflow rate depends on the difference of measured pressure between supply and extract air, and in this way the building pressure is ensured to be at the required value.

As explained above, there are three air handling units (AHU) installed in the building, one for each sub-system, but only the AHU TA/FA2 which serves the offices and a store with packing area is monitored constantly. Therefore, in the following analysis the focus is on the TA/FA2.

The AHU TA/FA2 serving the offices and a store with packing area works 24/7. Between 6:00 and 19:00 it delivers a supply of fresh air and heating, always recovering the thermal flux through a rotary heat recovery. During the night the AHU switches its function to a night mode.

Also the other AHUs TA/FA1 and TA/FA3 are equipped with heat recovery and the night mode section. Without people inside the building there is no need for constant supply of fresh air, yet at the same time there is a need to heat the building in order to avoid too large of a temperature drop. The system set up does not consider the need of ventilation at nights to avoid possible build-ups of VOC from the building materials.

5.2.2 Night mode

If one considers a winter night: there is possibility to lower the supply of fresh air inside the building (as a sum of airflow based on design occupancy rate and designated airflow per square meter). The night mode allows the energy saving by recirculation of the most part of indoor air (already at 20°C) with air supply according with the Swedish building regulation (Boverket, 2011) of 0,35 l/(s·m²) of fresh air for each zone. In this way the temperature difference between the recirculation air and the water in the coils is lowered. It means that the power supplied to the air is lower as well as the energy needed for heating the airflow from 14°C (possible temperature after the recovery) to 20°C. In addition this will allow the decreasing of the temperature by 2°C, in other words the extract air has to reach 18°C before the heating system increases the thermal power of water flow. Of course, during the transitory of night and day there will be a need for an increase of energy consumptions for the AHU to restore the operative indoor day conditions.

The energy saving is increased if one considers the particular design of an air handling unit in which a bypass section significantly reduces pressure drops, this means less energy consumption by fans. Figure 6 displays a scheme of the AHU TA/FA2 installed in the monitored sub-system.

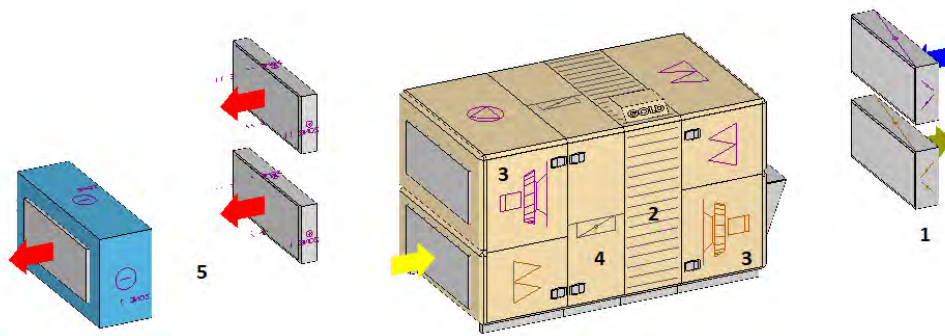

Figure 6 – TA/FA2 dampers (1), recovery (2), fans (3), bypass section (4) and coils (5)

5.2.3 HVAC production

Heating and cooling are furnished by a ground coupled double effect heat pump of 55 kW with a COP = 4,85 and a EER = 3,85 that during winter time takes heat from the ground, whereas during the summer it rejects the heat absorbed by the building back to the ground in order to avoid the thermal unbalance of it. Yet, in summer season too much heat from the building is extracted, so part of this heat is actually rejected outside by an external coil in order not to have the ground too warm at the beginning of heating season. As an auxiliary system is used an electric boiler of 42 kW and a classic split system cools the package area during summer time.

6 Monitoring

6.1 Monitored data

In order to evaluate the building performance the monitored data on indoor environment, air handling unit and weather data were collected to evaluate the entire system in respect to energy performance and indoor air quality. There is no monitored data on energy supplied to the building from the electrical grid and production from ground coupled double effect heat pump.

6.1.1 Indoor Environmental Data (IED)

The monitoring of indoor climate parameters (temperature and humidity) was accomplished at various building levels by probes installed in different places in the building: in offices and in the retail with packing area. IED records values of temperature and relative humidity in the rooms, in air diffusers and in coils (sensors placed before and after the coils in the ducts).

At the indoor level, due to the request from building management, extra loggers were placed in the packing area at different heights in order to evaluate the air stratification and to have a full overview of the climate inside the area. Furthermore, temperatures were monitored in local and main air ducts.

The sets of data are grouped together in a block called Indoor Environmental Data (IED). Data is recorded with a frequency of every six minutes.

The IED are stored in a computer reachable by remote connection for monitoring the system and downloading data. The recording system is linked to Onset Hobo Nodes (Onset, 2013) that communicate through a central computer with 3g modem via the web and are accessible here at the www.logmein.com website.

Data is collected with the following parameters:

1. Indoor level (in 3 office rooms, retail and packing):
 - Temperature and relative humidity in different points of different rooms as:
 - One office desk (approximately high of 1,1 m from the ground) labels 2110, 2109, 2108
 - Retail (approximately high of 1,7 m from the ground) label 101
 - Packing room (three highs 0,1 m, 1,1 m, 1,8 m from the ground) label 111
2. Local level (for each monitored active beam):
 - Primary air temperature is monitored in the ducts at central level
 - Secondary temperature
 - Inlet air temperature
 - Relative humidity for each temperature
3. Central level (in main air ducts):
 - Temperatures
 - Supply main duct before the AHU coil
 - Supply office main duct after the AHU coil (unknown distance from the coil)
 - Supply retail main duct after the AHU coil (unknown distance from the coil)

For more detailed information on the monitoring system see Appendix A.1.

6.1.2 Air Handling Unit Data (AHUD)

The TA/FA2 is monitored by an integrated measurement and control system that collects information about temperature, humidity, fans consumption, airflow and pressures. These parameters are grouped together in Air Handling Unit Data (AHUD). Time step is every 30 minutes.

For the AHU TA/FA2 are constantly monitored:

- Supply and extract airflows
- Temperature and relative humidity for supply, extract, fresh and exhaust airflow
- Pressure before and after the filters in the supply and extract ducts
- Specific fan power (SFP) and efficiency of the recovery in the rotary heat recovery are calculated with internal algorithms

For more detailed information on the monitoring system see Appendix A.1.

6.1.3 Weather data

A weather station was also considered in the monitoring system, collecting hourly data on the outdoor weather. Unfortunately, there were technical problems in the water seal, so the probe was completely damaged by the water. Therefore, the supplement data is from “Sveriges meteorologiska och hydrologiska institute” (SMHI). The downloaded SMHI weather data from the official webpage (SMHI, 2014) for the closest meteorological station (Torup A) to the installation site (Falkenberg) just 40 km.

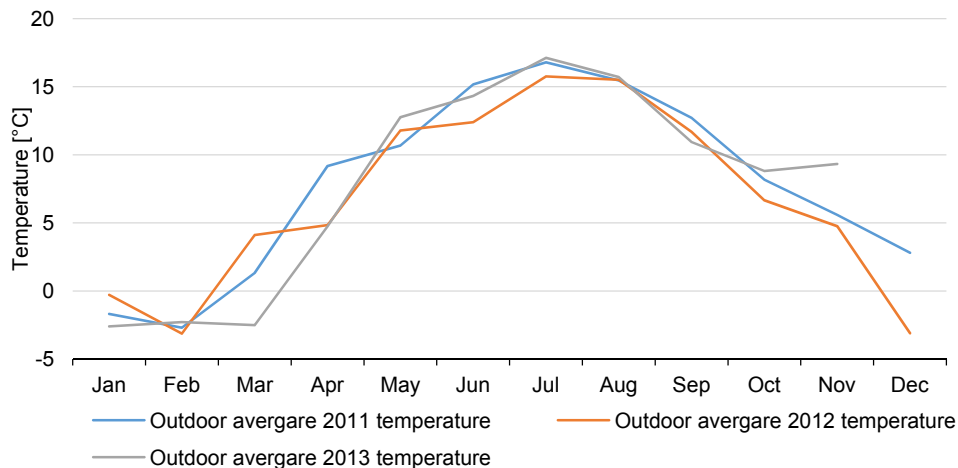

Figure 7 – Outdoor monthly average temperature in various years in Torup A (source SMHI)

See Appendix A.4 for detailed information on the percentage of available data and outdoor average temperature for all the months in the considered years.

6.2 Availability of data

6.2.1 IED - monthly percentage of available data for temperature

Looking at the IED records from years 2011-2013 at room level (2110, 2109, 111 and 101) shows that records for the rooms are mostly complete, yet for the rooms 111 and 101 there are some months where data is only partially recorded or completely missing due to malfunctioning probes.

For detailed information on available data for IED see Appendix A.4.

6.2.2 AHUD – monthly percentage of available data for temperature and airflow

Sorting of AHUD data shows that from recorded values of temperature and airflow it can be seen in Figure 8 that the most complete data can be found in year 2012.

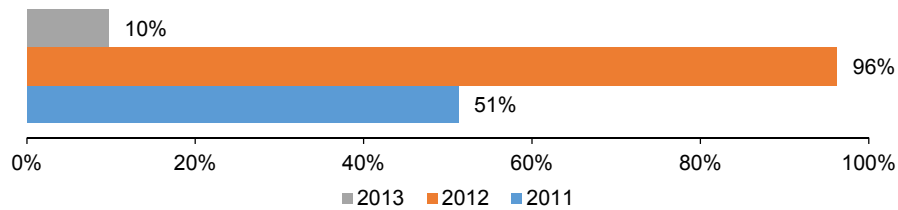

Figure 8 - AHUD – availability of data

For detailed information on available data for AHUD see Appendix A.4.

6.3 Data compatibility

In order to compare the different data, it was necessary to sort all data into average values using appropriate Microsoft Excel analysis. This step was necessary not only to sort data into hourly frequency, but also to make the whole data block more manageable while reducing remarkably their quantity, yet still holding quality.

6.3.1 Quantity compatibility

The following Figure 9 shows the periods of collected data for IED and AHUD. It can be seen that the period for the collected data for IED is much longer than the period for AHUD.

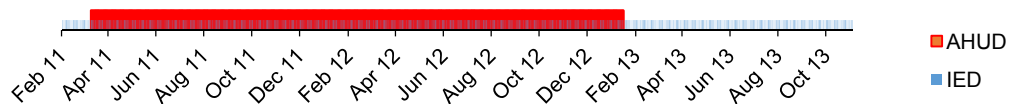

Figure 9 – Monitoring data for AHUD and IED

Because of that, there are two possible approaches to consider:

1. Use all collected data within the common period only, i.e. from April 2011 to February 2013;
2. Use all IED period to have a more detailed picture, i.e. as the ventilation system is a constant air volume (CAV) system, the airflow values do not have large fluctuation from the set point values. Because of that, the IED can be considered in order to have a detailed picture of the temperatures inside the monitored zones and wherever airflow records are missing, it can be completed with the set point airflow values.

The second approach is more adequate and was adopted to evaluate the monitored data.

6.3.2 Quality compatibility

Compatibility between AHUD and IED must be considered in order to make a choice about suitable supplement use of each record block. Both record blocks (AHUD and IED) have probes on temperatures in the main ducts for supply air. The difference between these two blocks is that, if the block AHUD has only one record for the temperature after the main coil, the IED block

has two records, one in the office duct and the other in the retail duct. The question is which of these two records might be used for the evaluation of the thermal capacity.

As the distance of different probes from the coil is unknown, for the IED block (which has two records) the average of these two hourly values was calculated (retail and office ducts).

Figure 10 shows the comparison between two temperatures in the common analysis period. That shows the compatibility of the two records and because the average drift of the two records is below 0,45°C, it is possible to use the IED records in the ducts to make calculations on the thermal capacity for each zone.

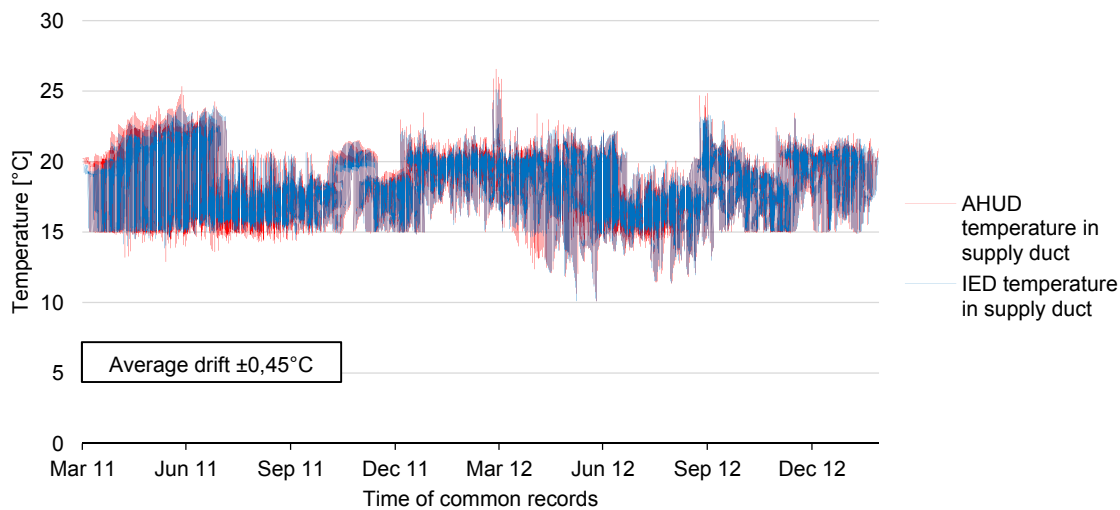

Figure 10 – Comparison between supply air duct temperature from AHUD and IED records

6.4 Detailed evaluation

6.4.1 IED

The interval of data collection for IED is 2011/09/30 – 2013/02/05.

Temperature

Referring to Figure 76 in Appendix A.4 it can be noted that all temperature profiles are similar. There are some periods with data missing from rooms 111 and 101 (white gaps). Due to the similarity of temperature profiles and the data missing it is possible to assume that the collected IED data is reliable.

Relative humidity

The relative humidity is recorded from the same probe of temperature and linked to the same collector, therefore, the same assumptions can be done for measurements of relative humidity as for temperature.

6.4.2 AHUD

The period of data collection for the AHU TA/FA2 is 2011/03/30 – 2013/02/05. From the entire period the following figures in this chapter can be extracted for airflow rates and temperatures.

6.4.2.1 Temperature

Looking at temperature profiles for supply temperature and outdoor temperature in Figure 11 it can be seen that the profile of supply temperature seems to be coherent with outdoor temperature.

In addition, there are no large gaps in the records.

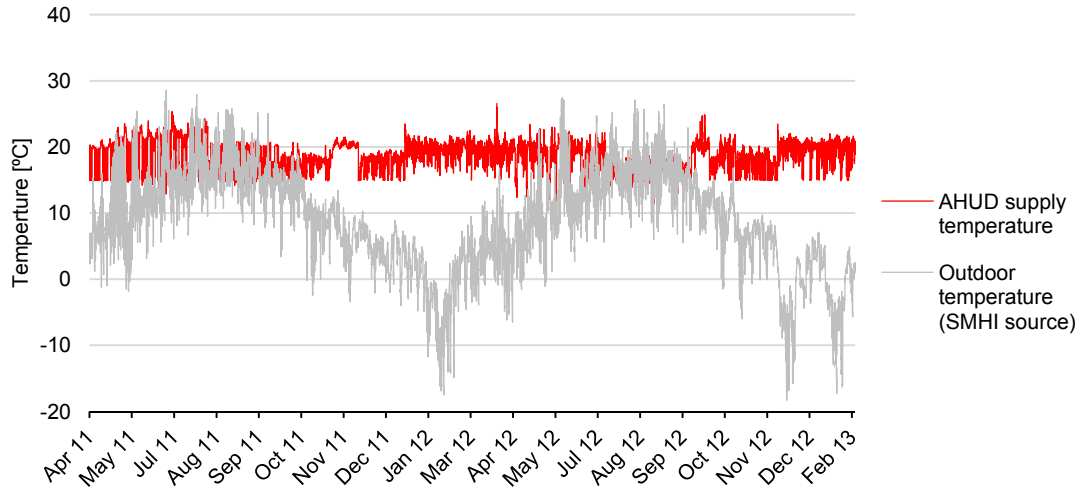

Figure 11 – Supply air and outdoor temperature

6.4.2.2 Airflow

Focusing on the chart in Figure 12 it can be seen that there is some missing data in 2011 and in 2012 (white gaps). In addition, there is a rise in the airflow values from the end of March 2012 due to the increase of airflow rate for extra 300 l/s in the packing zone.

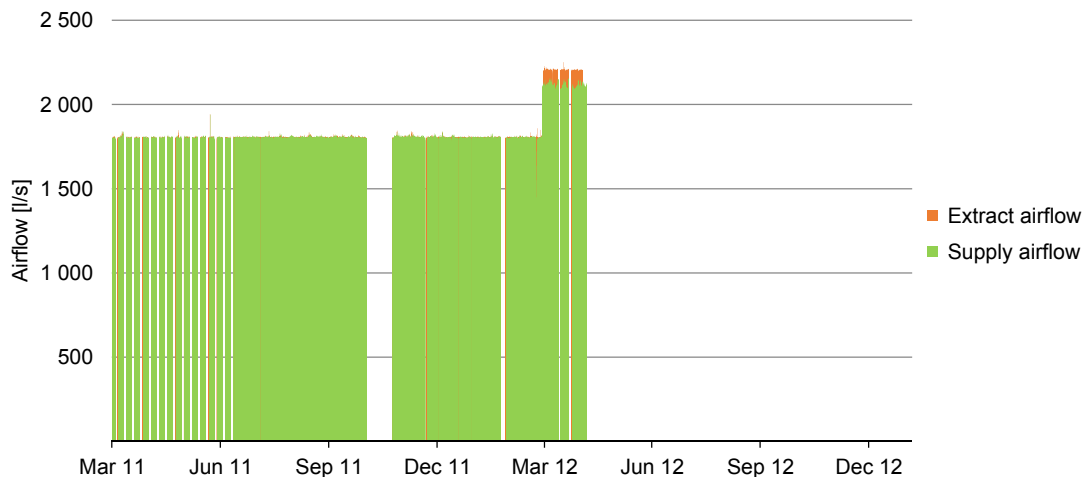

Figure 12 - Airflow data from TA/FA2

Zooming in on values from 1 700 l/s to 2 300 l/s in Figure 13 it is evident that before the increase of the airflow rate the building was pressure-balanced, after the increase of airflow the building is in under-pressure state. This might cause possible leakage of external air through the building envelope, which can cause inefficiency. Note that the evaluation of air tightness is not part of this study.

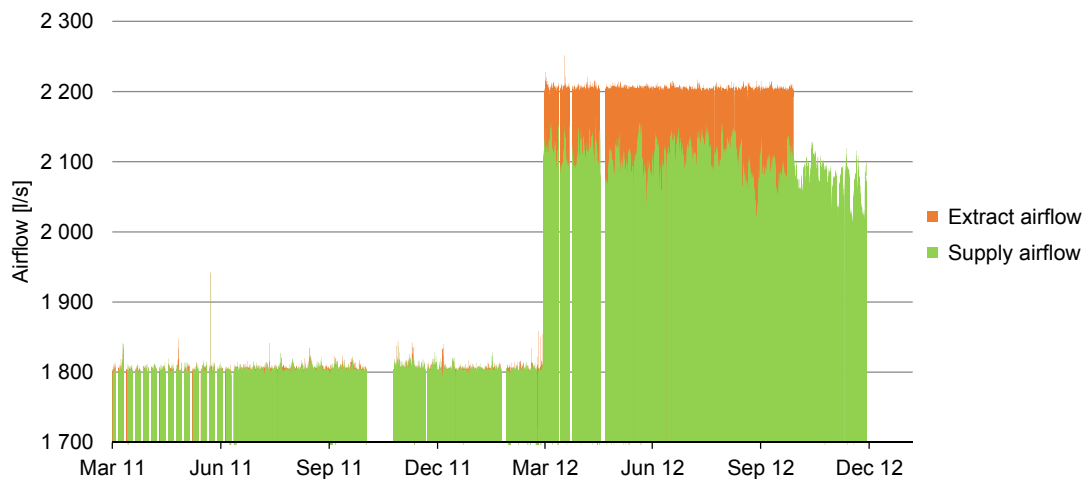

Figure 13 – Zoom on airflow in TA/FA2

6.4.2.3 Night mode

As described in paragraph 4.2.1 Ventilation, a bypass section was installed in AHU TA/FA2. Using this option during night-time and during people absence (Saturday afternoon, Sunday and holidays), the internal air is re-circulated in the building reducing the required thermal capacity. In addition, due to the bypass of the rotary heat recovery, this operating mode reduces the electrical power for the fans because they have less pressure drop to compensate.

Evaluation of the recorded data in daytime (8-18 h) and night time (19-5 h) shows that in both periods the data blocks are complete.

Because the specific fan power (SFP) is measured as a sum of specific power for both fans, the night mode regulation should allow decreasing the electric absorption of the exhaust fan and should significantly reduce the SFP. In Figure 14 it can be seen that is not happening during the standard functioning, perhaps due to a wrong regulation.

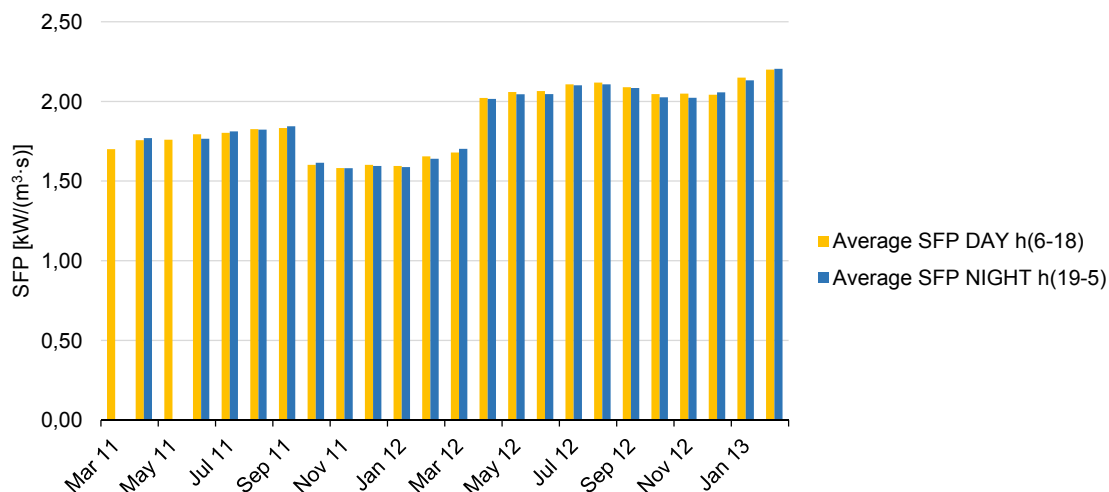

Figure 14 – Monthly average day and night SPF

6.5 Constructing of a Reference Year on Records (RYR)

In constructing of the reference year on records (RYR), which will be used in modelling for the purpose of matching between the real functioning (CAV) and the improvement of systems (DCV), these different aspects have to been considered:

- Quantity of records available
 - to investigate the amount of missing data in each year and select the year with the least amount of missing data
- Compatibility of records
 - to be able to fill missing data based on the fact of constant airflow values
- Coherence with outdoor temperature

6.5.1 Quantity of records available

Wherever possible, the common periods between the IED and AHUD records were used, and considering that the importance of the temperature records and completing the airflow data, where necessary, with the design value. Table 3 shows an overview of recorded data over a period of three years.

Table 3 – Overview of three years of indoor environmental and air handling unit data

2011	
Temperature	100% of missing data in January for all the labels More than 70% of missing data in February for all labels
Airflow data	56% available
Weather data	Complete
2012	
Temperature	Missing data for a room 101: September 60%, October 100%, November 100% and December 100% Missing data for a room: 111: December 54,3%
Airflow data	96.2% available
Weather data	Complete
2013	
Temperature	Missing data for a room 101: January 100%, February 15,9% Missing data for a room 111: January 100%, February 15,9% Missing data for all rooms: November 23,9% and December 100%
Airflow data	9,7% available
Weather data	Complete

Data from the year 2011 was taken as a reference year. In this year, the data of airflow was completed where needed and so was the temperature block for the months of January and February. A recap of 2011 available data (prior constructing RYR process) is given in Table 4.

Table 4 – Percentage of available data in year 2011 prior completion process

	Airflow	Temperatures					
		Coil	Room 2110	Room 2109	Room 2108	Room 111	Room 101
Jan	0%	0%	0%	0%	0%	0%	0%
Feb	0%	27%	27,1%	26,6%	26,6%	26,6%	26,3%
Mar	2,69%	100%	100%	100%	100%	100%	100%
Apr	37,78%	100%	100%	100%	100%	100%	100%
May	38,44%	100%	100%	100%	100%	100%	100%
Jun	39,72%	100%	100%	100%	100%	100%	100%
Jul	74,73%	100%	100%	100%	100%	100%	100%
Aug	100%	100%	100%	100%	100%	100%	100%
Sep	100%	100%	100%	100%	100%	100%	100%
Oct	98,79%	100%	100%	100%	100%	100%	100%
Nov	24,44%	100%	100%	100%	100%	100%	100%
Dec	93,28%	100%	100%	100%	100%	100%	100%

6.5.2 Compatibility of AHUD data and completion process

Integration of the airflow data in the air handling unit TA/FA2

Looking at the graph in Figure 15, the missing data (white gaps) can be completed, because of all the considerations done until now, with the setup value of 1 800 l/s.

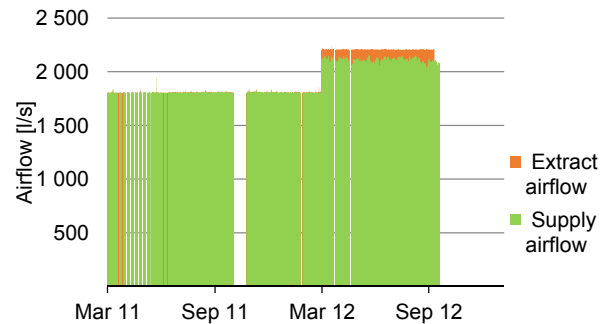

Figure 15 – Airflow data integrity

This choice is justified for both daily and night mode operation because of what was stated in chapter 4.2.2 for the SFP and airflow missing records.

Integration of data for which there are no information (January and February)

The yellow highlighted spots in Figure 16 are the data that has to be integrated in order to build the RYR.

	Airflow	Temperatures					
		Coil	Room 2110	Room 2109	Room 2108	Room 111	Room 101
Jan	0%	0%	0%	0%	0%	0%	0%
Feb	0%	27%	27,1%	26,6%	26,6%	26,6%	26,3%
Mar	2,69%	100%	100%	100%	100%	100%	100%
Apr	37,78%	100%	100%	100%	100%	100%	100%
May	38,44%	100%	100%	100%	100%	100%	100%
Jun	39,72%	100%	100%	100%	100%	100%	100%
Jul	74,73%	100%	100%	100%	100%	100%	100%
Aug	100%	100%	100%	100%	100%	100%	100%
Sep	100%	100%	100%	100%	100%	100%	100%
Oct	98,79%	100%	100%	100%	100%	100%	100%
Nov	24,44%	100%	100%	100%	100%	100%	100%
Dec	93,28%	100%	100%	100%	100%	100%	100%

Figure 16 - January and February data integration

To complete the total year data, as can be checked in Figure 16, instead of the records for January 2011 (where records are completely missing) and for February 2011 (for which just the 27% of records are available) the data recorded in the same months of 2012 or 2013 can be used.

Table 5 - Available data January, February 2012, 2013

	Airflow	Temperature					
		Coil	Room 2110	Room 2109	Room 2108	Room 111	Room 101
2012							
Jan	100%	100%	100%	100%	100%	100%	100%
Feb	85,27%	100%	100%	100%	100%	100%	100%
2013							
Jan	100%	100%	100%	100%	100%	0%	0%
Feb	15,92%	100%	100%	100%	100%	84,1%	84,1%

With reference to Table 5, for both months January and February, the best solution is to use the records achieved in 2012, more complete than the records in 2013.

In addition, January and February in 2012 are characterized by a setup airflow value of 1 800 l/s which ensure the compatibility of the data with the whole others 2011 records.

6.5.3 Coherence with outdoor temperature

Focusing on Table 6 on the outdoor monthly average temperature for the months of January and February, it can be seen that January 2012 has an average temperature beside the average of January 2011, differently February 2012 has a value below it. The choice of these months has been driven by the bigger quantity of available data, which allows a better definition of the use of energy in real outdoor conditions.

Year 2012 is a leap year, so, in order to have 8 760 hours the 29th of February was not considered.

Table 6 - Outdoor temperature

	2011		2012		2013	
	Available data %	Outdoor average temperature [°C]	Available data %	Outdoor average temperature [°C]	Available data %	Outdoor average temperature [°C]
Jan	99,73%	-1,68	100%	-0,28	100%	-2,60
Feb	100%	-2,70	100%	-3,13	100%	-2,28
Mar	100%	1,33	100%	4,11	100%	-2,51
Apr	100%	9,17	100%	4,84	100%	4,74
May	100%	10,68	100%	11,79	99,60%	12,76
Jun	100%	15,17	100%	12,39	100%	14,32
Jul	100%	16,79	100%	15,76	100%	17,12
Aug	100%	15,46	100%	15,51	100%	15,70
Sep	100%	12,71	100%	11,68	100%	10,94
Oct	99,73%	8,17	100%	6,65	99,73%	8,81
Nov	100%	5,58	100%	4,75	0,97%	9,33
Dec	100%	2,81	100%	-3,11	0%	-

6.5.4 Completed Reference Year on Records

The year for the evaluation of the energy consumption is composed as in Table 7.

Table 7 - Percentage of data in the Reference Year of Records

		Airflow		Temperature				
		Coil	Room 2110	Room 2109	Room 2108	Room 111	Room 101	
Jan	2012	100%	100%	100%	100%	100%	100%	100%
Feb	2012	85,27%	100%	100%	100%	100%	100%	100%
Mar	2011	2,69%	100%	100%	100%	100%	100%	100%
Apr	2011	37,78%	100%	100%	100%	100%	100%	100%
May	2011	38,44%	100%	100%	100%	100%	100%	100%
Jun	2011	39,72%	100%	100%	100%	100%	100%	100%
Jul	2011	74,73%	100%	100%	100%	100%	100%	100%
Aug	2011	100%	100%	100%	100%	100%	100%	100%
Sep	2011	100%	100%	100%	100%	100%	100%	100%
Oct	2011	98,79%	100%	100%	100%	100%	100%	100%
Nov	2011	24,44%	100%	100%	100%	100%	100%	100%
Dec	2011	93,28%	100%	100%	100%	100%	100%	100%

7 Environmental evaluation

From the recorded data, information about the Indoor Environmental Quality (IEQ) can be extracted in terms of the values of temperature and relative humidity in the different monitored zones of the building.

The period where the IEQ is needed is when the building is occupied, so only the working days are considered.

Note: Not considered are Sundays and the Swedish Public Holidays for Halland county reported in Table 8 (feiertagskalender, 2011), where the building is located. Other than that, during all working days the activities in the building follow the schedule in Table 9.

Table 8 - Swedish public holidays

Month	Days
January	1;6
April	24; 25
May	1
June	2;6;12;25
November	5
December	25;26

Table 9 - Working day Schedule

Working day	Opening Hours
Monday - Friday	7-18
Saturday	9-14

Note: All the data has been supplied by the working staff without an official calendar reference. Because of that, the following evaluation may be affected by errors.

One of the most important aspects in a HVAC system is the consistency of the indoor conditions of temperature and relative humidity inside standard values suggested by the European Standard (ISO 7730, 1994).

This work focuses on some critical weeks for the system and for the building for outdoor temperature and humidity and makes an analysis on the long period comfort condition based on the calculation of the environmental comfort indexes percentage of people dissatisfied (PPD) and predicted mean vote (PMV).

7.1.1 Indoor temperature during critical outdoor periods

For each year a week has been considered, including the maximum and minimum daily and weekly temperature, the daily and weekly maximum fluctuation for the outdoor temperature.

- The daily minimum and maximum to see the functioning during the temperature peaks;
- The weekly minimum and maximum to evaluate the functioning with a more long load (the daily minimum and maximum may not correspond to the weekly);
- The maximum fluctuation to evaluate the answers of the system to fast temperature variations

In Appendix A.4 detailed information can be found about the different weeks in the different years.

The analysis is done in the year 2012 because in this year all months are monitored. On the contrary, in 2011, January and the most of February (the coldest months) are missing and in 2013 the months from August to December are missing.

It is possible to draw the charts of Figure 80 - Figure 83, included in Appendix A.4 related to the different records such as secondary temperature (where installed on the active beam), rooms' temperature at 1,1 m high and stratification in packing zone.

In this work it was chosen to focus on the temperatures 1,1 m high from the ground because that position is much closer to the operative temperature than the others. Besides that, focus is also on the air stratification in the packing area because of complaints of cold discomfort during winter time.

In order to not weigh down this report, it has been chosen to include just an example of the graphs, to focus the attention on the temperature profiles for the outdoor and indoor air condition in the weekly minimum temperature. In addition, the stratification for the packing zone is reported in order to verify if the complaints received are justified.

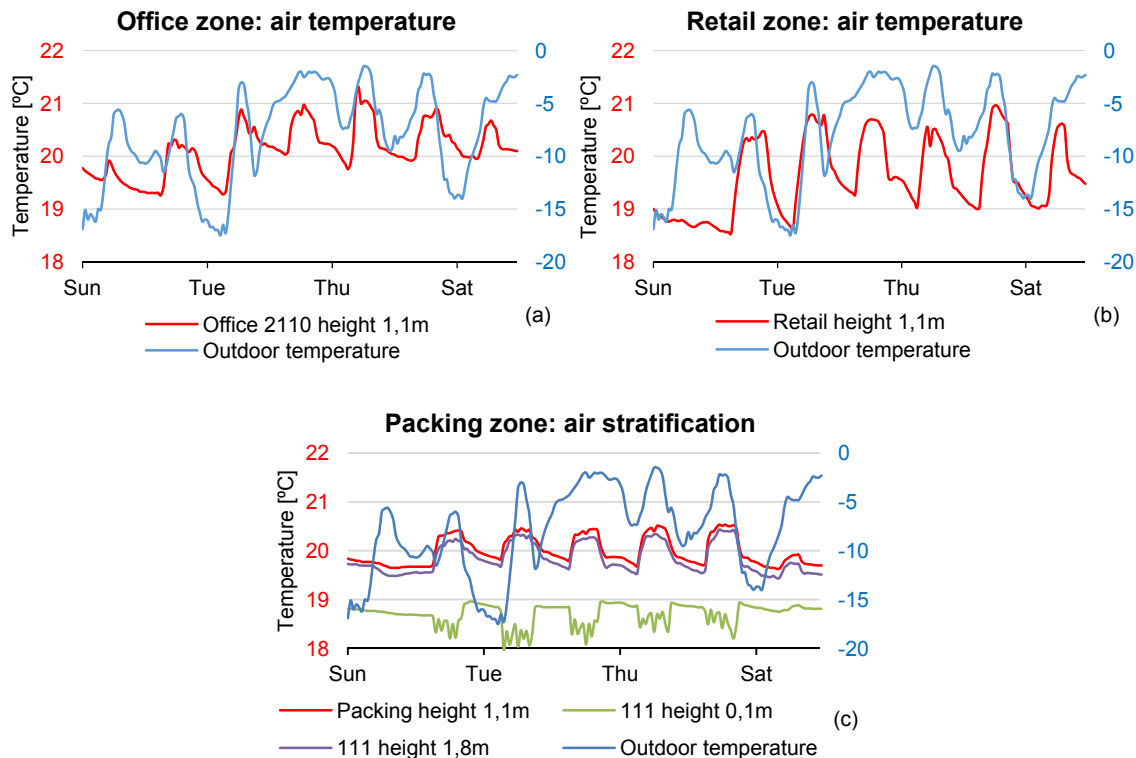

Figure 17 - Weekly minimum temperature

Focusing on the graphs in Figure 17 it is evident that the profile of the internal temperature is fluctuating exactly like the outdoor temperature, except for the weekend, for which, according to what is explained in chapter 4.2.2, a temperature drop is allowed during the weekends and the nights.

Referring to Figure 17, for the packing zone it can be seen that, besides the fluctuation as described above, the temperature at 1,1 m is higher than the temperature recorded at 1,8 m. This is unexpected, but might be explained with the proximity of computers that could influence the records.

However, the air stratification is not relevant in the packing area because, usually a temperature increase

of 1 K/m is allowed, but as can be seen in Figure 17 for the packing zone, between the lowest and highest probe, so a linear difference of 1,7 m, there is only 1 K gap.

In addition the temperature recorded at 0,1 m is almost low, around 18,5°C, that might be in accordance with the complaints received from the building management, therefore considering the particular aim of the zone (working area) and the analysis in chapter 6.1.2, there are no reasons to consider the complaints justified.

It should be taken into account that the analysis for the packing zone with result the graph of Figure 17 considers just one measurement location and might not be representative of the whole area,

in fact the complaints might be referred to the area close to the warehouse or the external walls.

Because of that, this analysis would need further investigations.

7.1.2 Long period Comfort

The aim of this chapter is to evaluate the long period comfort (LPC), in other words the monthly cumulate hours in which people, inside the monitored zones, have been out of their comfort boundaries.

“Thermal comfort is defined as that condition of mind which expresses satisfaction with the thermal environment. Dissatisfaction may be caused by warm or cool discomfort of the body as a whole as expressed by the PMV and PPD indices... ..Predicted Mean Vote (PMV) and Predicted Percentage of Dissatisfied (PPD) are two a dimensional values, the former predict the mean value of the votes of a large group of persons on the following 7 point thermal sensation scale” (ISO 7730, 1994)

The PMV gives information about the thermal feeling for a group of persons, but it does not give any information on the quantity of the thermally dissatisfied people Figure 18.

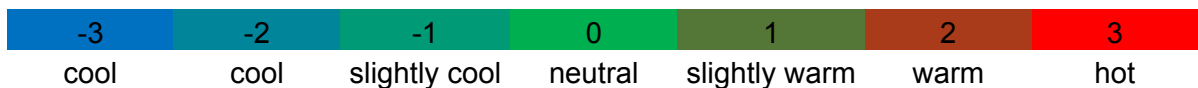

Figure 18 - PMV values

Because of that, the PPD is being introduced.

PMV and PPD are linked to one other with the curve in Figure 19, also showing the limits for the comfort zone (green in the sketch).

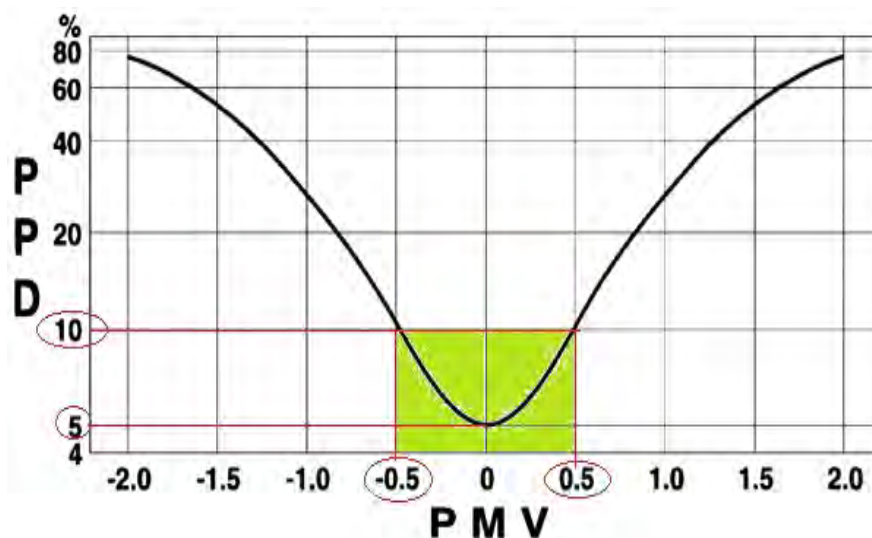

Figure 19 - Relation between PPD and PMV

As it can be seen the maximum of PPD usually accepted is 10% of dissatisfied people corresponding to $\pm 0,5$ for the PMV. The curve does not reach the 0% PPD because there is always 5% of people chronically dissatisfied.

PMV and PPD have been calculated according to the standard (ISO 7730, 1994) implementing the computer method included in the same standard (BASIC language) in (VISUAL BASIC language, compatible with Microsoft Excel).

The computer program is reported in Figure 84 of Appendix A.4 that uses the equations from (1) to (4):

$$PMV = (0,303 \cdot e^{-0,036M} + 0,028) \cdot \{(M - W) - 3,05 \cdot 10^{-3} \cdot [5733 - 6,99 \cdot (M - W) - p_a] - 0,42[(M - W) - 58,15] + -1,7 \cdot 10^{-5} M \cdot (5867 - p_a) - 0,0014M \cdot (34 - t_a) - 3,96 \cdot 10^{-8} f_{cl} \cdot [(t_{cl} - 273)^4 - (\bar{t}_r + 273)^4] - f_{cl} h_c (t_{cl} - t_a)\} \quad (1)$$

Where:

$$t_{cl} = 35,7 - 0,028 \cdot (M - W) - I_{cl} \cdot \left\{ 3,96 \cdot 10^{-8} f_{cl} \left[(t_{cl} + 273)^4 - (\bar{t}_r + 273)^4 \right] + f_{cl} h_c \cdot (t_{cl} - t_a) \right\} \quad (2)$$

$$h_c = \begin{cases} 2,38 \cdot (t_{cl} - t_a)^{0,25} & \text{for } I_{cl} \leq 0,078 \frac{m^2 \cdot ^\circ C}{W} \\ 12,1 \cdot \sqrt{v_{ar}} & \text{for } I_{cl} > 0,078 \frac{m^2 \cdot ^\circ C}{W} \end{cases} \quad (3)$$

$$f_{cl} = \begin{cases} 1,00 + 1,290 \cdot I_{cl} & \text{for } I_{cl} \leq 0,078 \frac{m^2 \cdot ^\circ C}{W} \\ 1,05 + 0,645 \cdot I_{cl} & \text{for } I_{cl} > 0,078 \frac{m^2 \cdot ^\circ C}{W} \end{cases} \quad (4)$$

Where:

$q_{t,i}$	thermal capacity in the single zone i	[W]
PMV	predicted mean vote	
M	metabolic rate 1MET=58,2[W/m ²]	
I_{cl}	thermal resistance of clothing 1CLO=0,155[W/m ²]	
f_{cl}	ratio of man surface area while clothed to man's surface while nude	
t_a	air temperature	[°C]
\bar{t}_r	mean radiant temperature	[°C]
v_{ar}	air velocity relative to the human body	[°C]
p_a	partial vapour water pressure	[Pa]
h_c	convective heat transfer coefficient	[W/(m ² ·K)]
t_{cl}	surface temperature of clothing	[°C]

MET and CLO evaluation

To evaluate the metabolic rate (MET), function of the activity, and the thermal resistance of clothing (CLO) two different methods are being used:

MET:

according to standard (ISO 7730, 1994) in Figure 62 reported in Appendix A.3, a different value has been chosen according to the zones as shown in Table 10.

Table 10 - met for the different aim of zone (ISO 7730, 1994)

Zone	met
Office	1,2
Retail	1,6
Packing	1,6

CLO:

People choose how to dress in relation to the outdoor temperature. (De Carli, M, 2006) found a relation between CLO and mean outdoor daily temperature so CLO is evaluated in the RYR with equation (5).

$$clo = 0,9343e^{-0,0127 \cdot \bar{t}_{day,out}} \quad (5)$$

Where $\bar{t}_{day,out}$ is the mean outdoor daily temperature.

Evaluated the hourly PMV and PPD to evaluate the long term comfort conditions, comfort deviation has been quantified by the parameter weighting factor (Olesen, 2000) defined as in equation (6)

$$w_f = \frac{PPD}{PPD_L} \quad (6)$$

The sum of weighting factors throughout the investigated period allows for calculation of the parameter weighted time (WT) defined as equation (7).

$$\begin{aligned}
 WT_{warm} &= \sum_1^n w_f \Delta \tau && \text{when } PMV > PMV_L \\
 WT_{warm} &= \sum_1^n w_f \Delta \tau && \text{when } PMV < PMV_L
 \end{aligned} \quad (7)$$

Where n is the number of simulations in which the people are present and $\Delta \tau$ is the time step of simulation (hourly in this analysis).

Some authors assert that an appropriate value of comfort conditions may be 100-150 h/a out the comfort zone.

In existing standards there is still no limit values for this parameter, but it is necessary to consider the procedure, the building and the geographical position to understand where to go for the optimization of comfort conditions without increasing the energy need of the building too much (De Carli, M, 2006).

In the present work the WT warm and cool are evaluated for the different zones and they are compared with the mean monthly temperature recorded in the same zone.

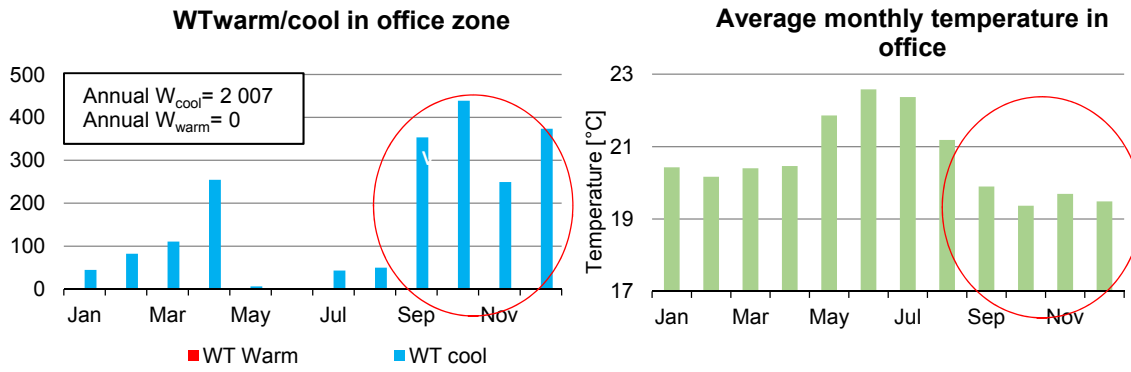

Figure 20 - Annual weighted time (office zone)

Figure 20 shows a significant value of cool thermal discomfort in the office zone, besides the correlation between the increasing cool discomfort and the decrease in the temperature are marked. As expressed before, the location of the building has to be considered.

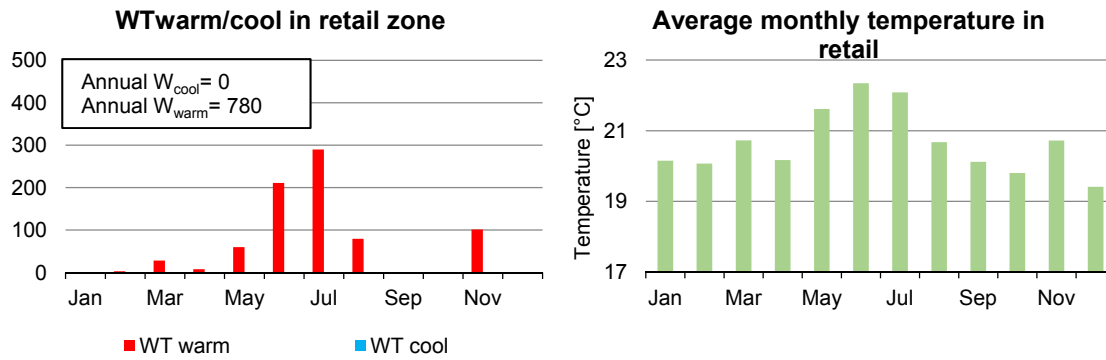

Figure 21 - Annual weighted time (retail zone)

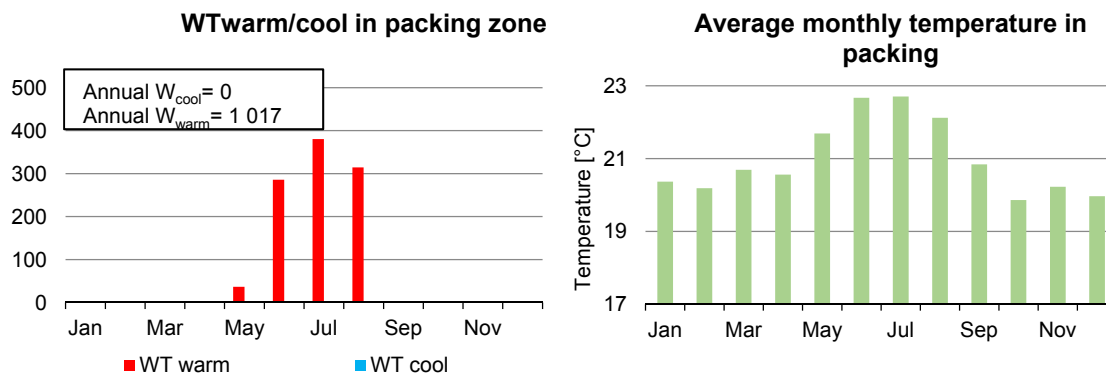

Figure 22 - Annual weighted time (packing zone)

In the retail and the packing zones (Figure 21 and Figure 22) the same relation with the recorded temperature can be seen. The indoor temperatures in these two graphs are almost the same as the ones recorded in the office. The differences between the warm or cool discomfort can be explained because of the differences in the *MET* parameter, Table 10.

From that analysis, the different types of discomfort in the zones of the building can be determined.

That analysis is done with standardized parameters, not considering the real thermal feeling of people inside the building.

Because of that more investigations might be interesting, through interviews with the employees and the customers with non-invasive methods, e.g. pressing a button at the exit of the retail/building (already used in other large chain shops).

In addition, it is interesting to consider that in the zone with high personalization of the temperature (offices) the only discomfort condition is the cool one, otherwise in the centralized controlled zones (retail and packing) only warm discomfort is noticed, coherently with the post installation of a standard split in the packing and fan coils in the retail. That allows one to think that a colder temperature is desired inside the building coherent with the theory of the adaptive thermal comfort (Nicol, et al., 2002) that take into account that humans can adapt and tolerate different temperatures during different times of the year and different geographical regions.

Because of that, the large value of thermal discomfort in the cool side for the office zone $WT_{cool} = 2.007$ in Figure 20. Would require more attention and more analyses that were not performed in this work.

8 Estimated energy consumption based on thermal capacity and power

In the following chapter in order to assess the energy demanded from the monitored sub-system, starting from the records acquired during the monitoring, the thermal capacity through each component was calculated and consequently the monthly and annual demand of energy.

It is very important to know the energy demand for a building because information can be supplied about the good performances of the system and give specific targets on possible improvements in the HVAC system and/or in the building envelope. Moreover, the analysis on the consumptions conveys forecasts on the expected operating cost of the whole facility.

Unfortunately, the monitoring system records data only on the sub-system served by the AHU TA/FA2. Because of that, an exact prevision for the overall building can be done only through hypothesis on the sub-systems served by the AHUs TA/FA1 and TA/FA3.

As described in chapter 4.2, the monitored area served by the AHU TA/FA2 can be split into three zones based on the different purpose of each zone and based on the different way of supply of thermal energy. Figure 23 shows how the different zones are connected to the same AHU TA/FA2.

In the office zone, active beams are installed with four pipes system to ensure a high level of personalization of temperature and high level of comfort. The packing zone is equipped with air diffusers and an active beam for cooling, both installed in ceiling. Later in time an additional split for cooling and an additional fan coils for heating were installed. In the retail zone, air diffusers connected to the AHU TA/FA2 are installed through an additional heating coil. Later in time, two additional fan coils were also installed to deal with overheating in summer.

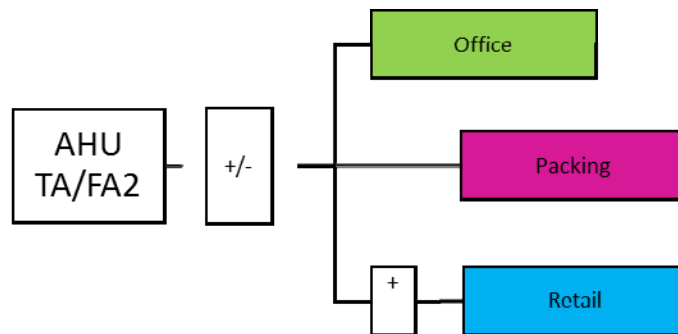

Figure 23 - Connection between AHU TA/FA2 and zones

Note that the additional post-installed equipment (fan coils and traditional split in packing zone, and fan coils in the retail zone) is not monitored. Due to this fact, all the thermal capacity was considered supplied from the central system, i.e. AHU TA/FA2.

8.1 Thermal Capacity

To evaluate the overall thermal capacity supplied to the monitored sub-system it is necessary to split it into the single zones' thermal capacity and evaluate it separately. In each evaluation, the thermal capacity produced in each zone was summed to the thermal capacity supplied from the AHU, see equation (8).

Because the analysed system is a CAV system, the same amount of air, which corresponds to the design airflow value, flows constantly through the different zones. Therefore, the thermal capacity provided to the single zone can be calculated as the thermal capacity calculated across

the central coil multiplied with the ratio between the design zone airflow and the total airflow handled in the AHU TA/FA2, equation (9).

$$q_{t,i} = q_{t,C,i} + q_{t,L,i} \quad (8)$$

$$q_{t,C,i} = q_{t,C} \cdot \frac{\dot{m}_i}{\dot{m}_{tot}} \quad (9)$$

Where:

$q_{t,i}$	thermal capacity in the single zone i	[W]
$q_{t,C,i}$	thermal capacity supplied to the single zone i from the AHU TA/FA2	[W]
$q_{t,C}$	overall thermal capacity handled from the central AHU	[W]
$q_{t,L,i}$	thermal capacity produced locally in the zone i	[W]
\dot{m}_i	airflow for the single zone	[l/s]
\dot{m}_{tot}	overall airflow	[l/s]

The temperature difference before and after each coil was evaluated in order to calculate the thermal capacity with equation (10). The temperature difference of $-0,5^{\circ}\text{C} \leq \Delta t \leq +0,5^{\circ}\text{C}$ was not taken into account in the thermal capacity evaluation and it is assumed that this temperature difference might be due to the wrong records or to thermal interferences in the probes.

$$q_t = \frac{\dot{m}_t}{1000} \rho c_p \Delta t \quad (10)$$

Where:

q_t	hourly average thermal capacity	[W]
\dot{m}_t	design airflow for the considered zone	[l/s]
$\rho = 1,204$	density of the air at 20°C	[kg/m ³]
$c_p = 1005$	specific heat for the air	[J/(kg.K)]
Δt	temperature difference considered in the calculation	[$^{\circ}\text{C}$]

The average power in the monitored area was calculated with equation (11) as sum of all hourly thermal capacities.

$$q_t = \sum_{i=1}^3 q_{t,i} \quad (11)$$

Office zone

For the office zone, the thermal capacity was evaluated by adding the part of thermal capacity supplied by the AHU TA/FA2 and the part of thermal capacity produced by every beam installed in the zone, Figure 24.

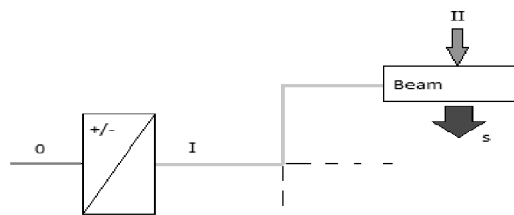

Figure 24 - Main coil and active beam, label description

Equation (12) gives the detailed balance for the evaluation of the thermal capacity in the office zone.

$$q_{\text{office}} = \left(\sum_{b=1}^n \frac{\dot{m}_{i,b}}{1000} \right) \rho c_p (t_i - t_o) + \sum_{b=1}^n \left\{ \left(\frac{\dot{m}_{i,b}}{1000} + \frac{\dot{m}_{ii,b}}{1000} \right) \rho c_p \left[t_{s,b} - \left(t_{i,b} \frac{\dot{m}_{i,b}}{\dot{m}_{ii,b}} + t_{ii,b} \left(1 - \frac{\dot{m}_{i,b}}{\dot{m}_{ii,b}} \right) \right) \right] \right\} \quad (12)$$

Where:

b	single beam	
$\dot{m}_{i,b}$	airflow rate of the primary air for each beam <i>b</i> , known by the design schedule	[l/s]
$\dot{m}_{ii,b}$	induction airflow rate for each beam, known by the selection program of the production factory and assumed constant in the entire analysis	[l/s]
t_i	temperature after the main coil	[°C]
t_{ii}	temperature for the secondary air in the beams	[°C]
t_s	temperature supplied from the beam	[°C]

Packing zone

The same assumption done for the office zone is also valid for the packing zone. Equation (13) gives the detailed balance for the evaluation of the thermal capacity in the packing zone.

$$q_{\text{packing}} = (\dot{m}_c + \dot{m}_b) \rho c_p (t_i - t_o) + \rho c_p \left\{ \left(\frac{\dot{m}_{i,b}}{1000} + \frac{\dot{m}_{ii,b}}{1000} \right) \rho c_p \left[t_{s,b} - \left(t_{i,b} \frac{\dot{m}_{i,b}}{\dot{m}_{ii,b}} + t_{ii,b} \left(1 - \frac{\dot{m}_{i,b}}{\dot{m}_{ii,b}} \right) \right) \right] \right\} \quad (13)$$

Where:

\dot{m}_c	ceiling airflow	[l/s]
-------------	-----------------	-------

Note that because there is detailed information about functioning time for the extra equipment (split unit for cooling and fan coils for heating), all thermal capacity for heating and cooling is assumed to be attributed to the airflow.

Retail zone

The same assumption done for the office zone is valid for the retail zone with reference to Figure 25 and equation (14) where the labels were explained in the prior text of this chapter.

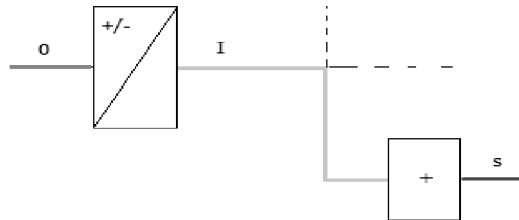

Figure 23 - Main coil and additional coil, label description

$$q_{\text{retail}} = \dot{m}_r \rho c_p (t_i + t_o) + \dot{m}_r \rho c_p (t_s - t_i) \quad (14)$$

Note: Because there is no detailed information about functioning time for the extra equipment in retail zone (fan coils for cooling), all additional thermal capacity cooling is assumed to be attributed to the airflow.

The consequence of evaluating the thermal capacity with equations (10), (11), (12), (13) and (14) is that positive temperature differences are related to heating and negative temperature differences are related to cooling. In graph displayed in Figure 25 the division between above zero line as heating and below zero line as cooling can be seen.

Figure 25 shows the profile of the thermal capacity in the different zones during the RYR. In the same graph, the calculated thermal capacity is related to the outdoor temperature in order to evaluate if the action of the HVAC system is coherent with the demand of heating and cooling.

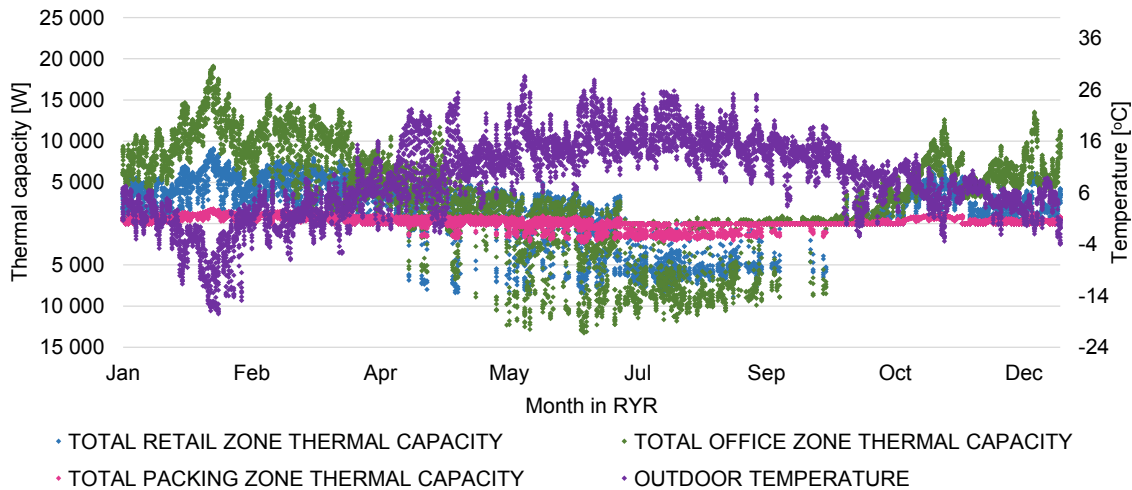

Figure 25 - Thermal capacities for thermal zones compared to outdoor temperature (SMHI)

At first sight, it can be seen that the overall profile is coherent; especially all the peaks in both summer and winter period between thermal capacity and outdoor temperature seem to be in coherence. Looking at the winter period, all thermal capacity profiles and outdoor temperatures are very symmetrical. Differently, in a more temperate season the building needs heating and cooling at the same time according to the different destination of the zones. In this situation even if the overall profile is respected, is much more difficult to identify the heating or cooling operation.

Summing the thermal capacity obtained for each zone it can be seen in the chart in Figure 26, which represents the total sum of thermal capacities supplied to the monitored sub-system. The sum of all thermal capacities is used to verify the thermal balance of monitored sub-system.

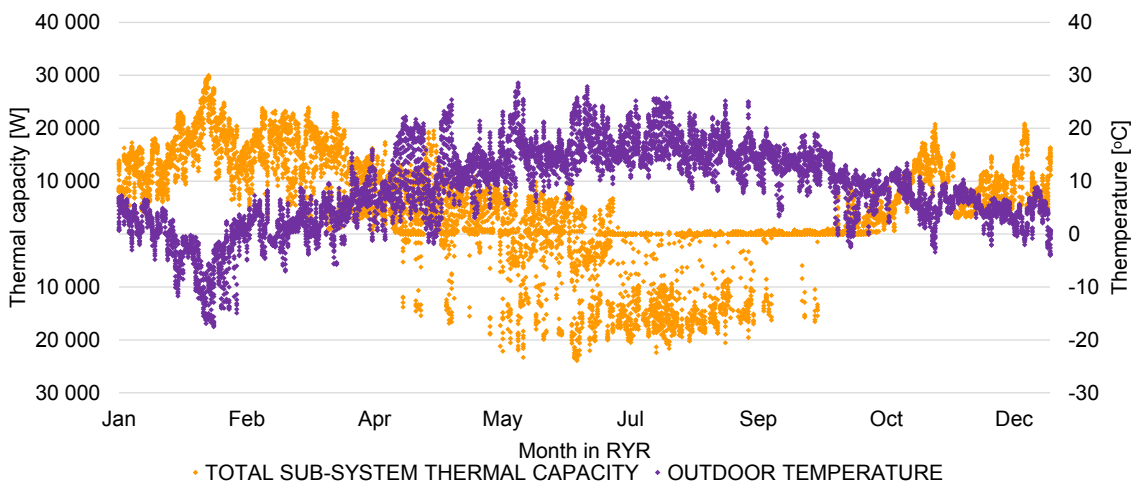

Figure 26 – Sum of thermal capacities delivered to monitored zone 2 compared with outdoor temperature

8.2 Energy evaluation

In this chapter, starting from the knowledge of the thermal capacity, the energy demanded in the single zone of the monitored sub-system can be assessed.

The thermal capacity calculated in chapter 5.1 is an hourly average thermal capacity. Because of that the hourly thermal energy can be evaluated by multiplying the value of thermal capacity for the interval considered, of rather one hour. In this way the hourly energy needed by the considered zone can be calculated ($e_{t,i}$ [kWh_t]).

The monthly demand of thermal energy $\bar{e}_{t,i}$ [kWh_t/m²] for the considered zone was calculated with equation (15).

$$\bar{e}_{t,i} = \frac{\sum_{i=1}^{24} e_{t,i}}{s_i} \quad (15)$$

Where:

$\bar{e}_{t,i}$	monthly demand of thermal energy	[kWh _t /m ²]
s_i	square foot each of the considered zone	[m ²]
n	number of the days for the considered month	

The monthly energy profiles for the considered zones are reported in Appendix A.4, Figure 99 for the office zone, Figure 100 for retail and Figure 101 for packing.

The electric power required by fans is calculated using the knowledge of the specific fan power (SFP [kW/(m³/s)]) which was obtained from the monitored AHU TA/FA2. The SFP in AHU TA/FA2 is calculated based on internal algorithms.

The electric power, as the thermal capacity, is calculated as an hourly average value and it is possible to determine the hourly average electric energy for fans with equation (16).

$$q_{f,el} = \text{SFP} \frac{\dot{m}_{tot}}{1000} \quad (16)$$

Where:

$q_{f,el}$	electric capacity for fans	[kW]
SFP	specific fan power	[kW/(m ³ /s)]
\dot{m}_{tot}	overall airflow	[l/s]

Based on company's experience the increase or reduction of the airflow by a specific percentage will change the SFP approximately by the same percentage. Because of that and because the SFP is measured as overall value for the total airflow, it is possible to split this value into the single zones using a linear correlation between SFP and airflow.

SFP for a single zone was scaled based on the ratio between the total airflow handled by the AHU TA/FA2 and the design airflow value flowing to the single zone.

That is possible because the relation expressed in equation (17) is always valid.

$$\text{SFP} \cdot \dot{m}_{tot} = \text{SFP} \frac{\dot{m}_{office}}{\dot{m}_{tot}} + \text{SFP} \frac{\dot{m}_{retail}}{\dot{m}_{tot}} + \text{SFP} \frac{\dot{m}_{packing}}{\dot{m}_{tot}} = q_{el,i,office} + q_{el,i,retail} + q_{el,i,packing} \quad (17)$$

The monthly specific average electric energy correlated to the fans in each zone $\bar{e}_{el,f,i}$ [kWh_e/m²] is expressed with equation (18).

$$\bar{e}_{el,f,i} = \frac{\sum_{i=1}^n \left(\sum_{j=1}^{24} e_{f,el,i} \right)}{s_i} \quad (18)$$

Where:

$\bar{e}_{el,f,i}$ specific monthly average fans energy [kWh_e/m²]
 $e_{el,f,i}$ specific hourly average fans energy [kWh_e/m²]

Due to the fact that the source for the thermal capacity is a ground coupled double effect heat pump with a COP = 4,85 and a EER = 3,85, the monthly thermal energy can be converted into electrical energy with equation (19) for the heating and equation (20) for the cooling energy. This electrical energy is the purchased source for the production of thermal energy through the heat pump.

$$\bar{e}_{el,h} = \frac{\bar{e}_{t,h}}{COP} \quad (19)$$

$$\bar{e}_{el,c} = \frac{\bar{e}_{t,c}}{COP} \quad (20)$$

Where:

$\bar{e}_{el,h}$ purchased energy used for the heating purpose [kWh_e/m²]
 $\bar{e}_{el,c}$ purchased energy used for the cooling purpose [kWh_e/m²]

Because of that it is now possible to compare the electrical energy consumed for the ventilation by fans, and the primary electric energy used for the thermal capacity in a building.

Figure 27, Figure 28 and Figure 29 show respectively for office, retail and packing zone, the comparison between the electric energy absorbed for the specific purposes of ventilation and thermal capacity. In addition, a bar chart with the composition of the monthly electric energy used in the different zones is also shown.

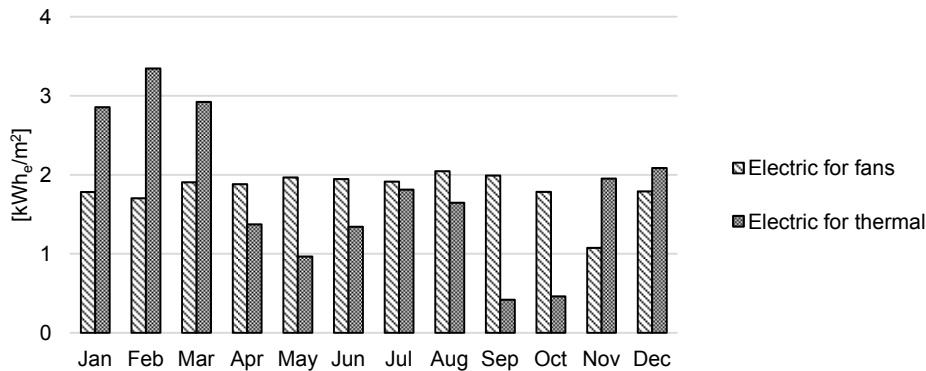

Figure 27 – Office zone: specific electric energy

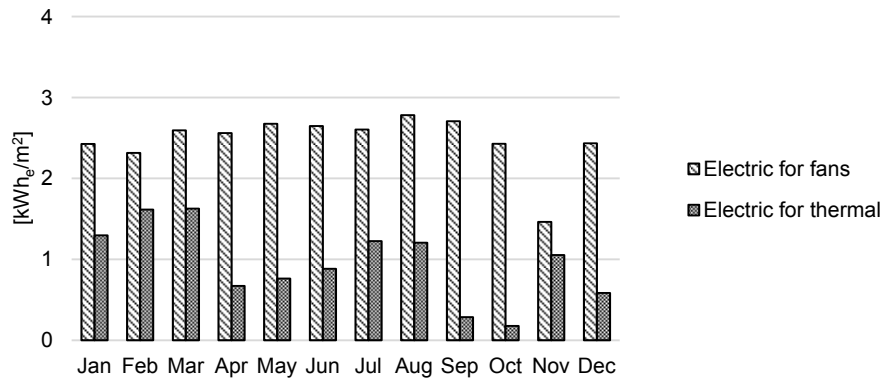

Figure 28 - Retail zone: specific electric energy

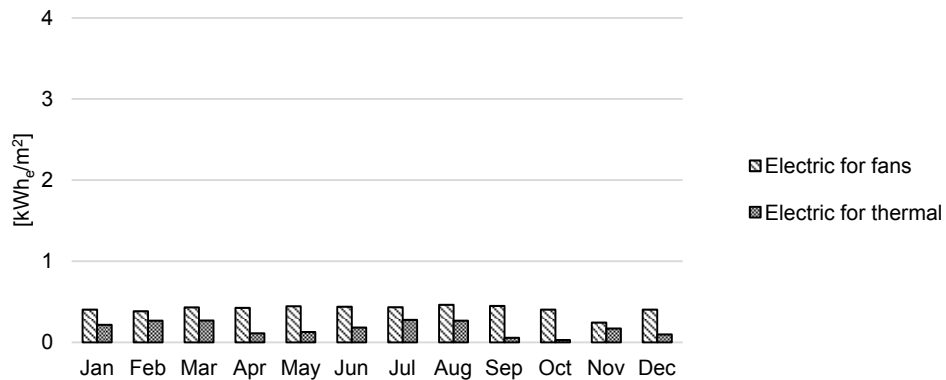

Figure 29 - Specific electric energy (thermal and electric) for packing area

In conclusion, by adding the total monthly specific electric energy for each zone it is possible to evaluate the total annual average specific electric energy $E_{el,i}$ [$kWh_e/(m^2.a)$] supplied to each zone. The annual demand of energy is reported in Table 11.

Table 11 - Zone demand of energy

Zone	Annual demand of energy [$kWh_e/(m^2.a)$]
Office	41
Retail	43
Packing	7

In Table 11 it can be seen that, for the office and retail zones the consumptions are comparable, otherwise for the packing zone the specific consumption seems to be too low.

In addition, for all the three zones the consumption is quite small compared to other buildings in the same region, finding that it is coherent with the technical description of the building that was designed as a high performance facility.

Conclusion on energy evaluation

In the previous charts (Figure 27, Figure 28 and Figure 29) it is important to focus the attention on the weight of the energy used for ventilation and thermal capacity. It can be seen that ventilation has a large influence on the overall consumption.

In these charts it is important to focus on the contribution that the energy for ventilation has on the overall consumption. The contribution for ventilation seems to be much more important in the zones air conditioned such as retail and packing.

This consideration leads to a finding that a DCV system, due to its ability to supply essential air volume based demand, could have large positive effects on energy reduction.

From the results of the total demand of energy in Table 11, the value for energy consumption calculated for the packing zone seems to be too small compared to the other two zones (office and retail). This matter will be further investigated in this thesis.

The overall building value of energy consumption is not the main target of the study, however, for an analysis completeness was estimated. Because the other two sub-system were not monitored, the building consumption is based on two hypothesis.

For the rented office sub-system, because its layout is approximately the same of the analysed office zone, the same amount of energy was assessed for the analysed office zone, such as $41 \text{ kWh}_e/\text{m}^2$.

Differently for the warehouse sub-system was taken as consumption the value of $100 \text{ kWh}_e/\text{m}^2$ because of the knowledge of similar facilities in the Scandinavian country. It is a rough approximation because of the lack of studies of the energy consumption for warehouses.

8.3 Building classification

This chapter describes the classification of the analysed sub-system according with European Standard (EN 15251, 2007). The following analysis was performed during the occupied period in order to understand how the energy saving might be improved by keeping or increasing the classification of the facility in the monitored sub-system.

According to European Standard (EN 15251, 2007), the monitored building can be classified following several parameters such as thermal comfort, energy, ventilation rate, CO_2 concentration, air change rate, humidity, lightning and noise. In this work, considering the available data, the choice was to focus on energy and humidity classification.

The classifications are given by the tables A.3 and B.3 from European Standard (EN 15251, 2007) reported in Appendix A.3.

Because the building has a four pipes system, heating and cooling can appear simultaneously in different zones. Because of that consideration, heating and cooling functioning are not clearly defined.

To classify the building according with (EN 15251, 2007) there is the need of a clear split in heating and cooling operation. Because of that, based on a routine for the evaluation of cooling and heating period in the residential building category, the operation during the months with the monthly outdoor mean temperature below 12°C was considered as heating. Differently, the cooling operation was considered if the outdoor monthly mean temperature was above 12°C .

As described in 4.2, the monitored sub-system is split into three zones because of the thermal capacity and air supply method (offices, retail and packing). Because of that, there is the necessity to classify the single zones separately.

Besides, for the office zone the analysis is reported only for the office room labelled as 2110, which is the largest room and it has the most disadvantages due to the adjacency to a warehouse (Figure 4). Referring to Figure 30 and to the definition of the winter and summer periods, the number of values concentrated in each "ring class" were measured.

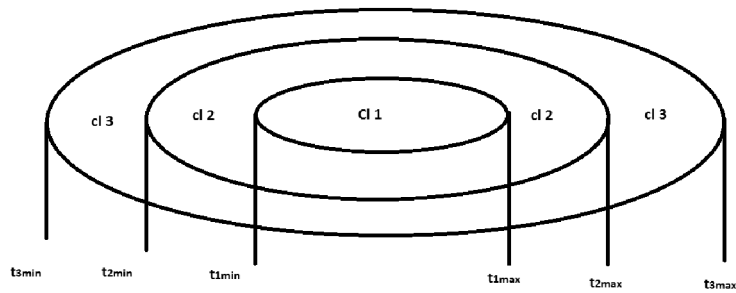

Figure 30 - Representation of energy class using “ring class”

Note: because the energy consumption is not the main aim of the thesis, the following analysis is a rough calculation based on cooling and heating periods that were established earlier.

8.3.1 Relative humidity classification

In this sub-chapter the building classification based on the relative humidity monitored in the building was assessed. The following analysis follows the guidelines of European Standard (EN 15251, 2007).

“The humidification of indoor air is usually not needed. Humidity has only a small effect on thermal sensation and perceived air quality in the rooms of sedentary occupancy, however, long term high humidity indoors will cause microbial growth, and very low humidity, (<15-20%) causes dryness and irritation of eyes and air ways. Requirements for humidity influence the design of dehumidifying (cooling load) and humidifying systems and will influence energy consumption. The criteria depend partly on the requirement for thermal comfort and indoor air quality and partly on the physical requirements of the building (condensation, mould etc.)” (EN 15251, 2007).

The humidity is not the main feature in a building, but it is an important aspect in the comfort evaluation. A low quantity of water in the air may causes dryness to throat, nose and eyes and consequently discomfort. Otherwise a high value of relative humidity may provoke moisture on walls that may have effect on the shape’s integrity and on the growth of mould with the consequence of allergies or growth of bacteria.

During the occupied period, only the mean recorded value was evaluated for the indoor relative humidity in the three zones analysed. In addition, were counted how many values are inside the boundaries of the different class stated in the European Standard (EN 15251, 2007).

Figure 31 shows the results of the humidity classification where can be seen that all the zones fall in class I.

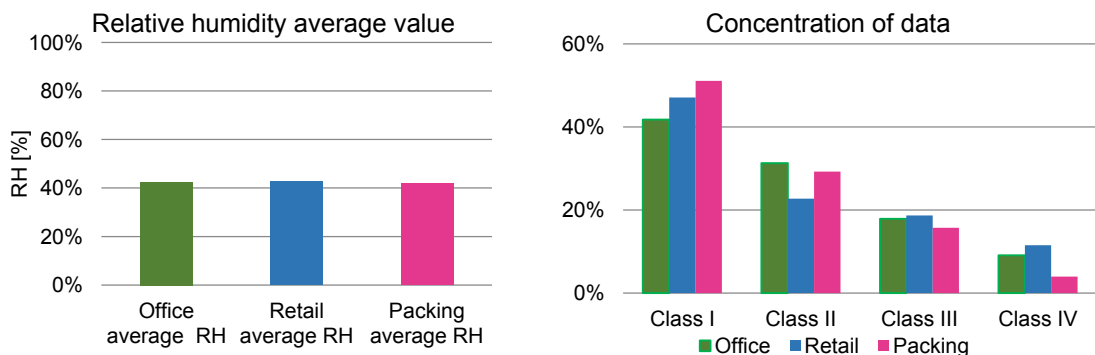

Figure 31 - Relative humidity classification

8.3.2 Energy Classification

With reference to the European Standard (EN 15251, 2007) and Figure 63, it is possible to classify the building with the recorded temperature in three classes: class 1, class 2 and class 3.

Because of the different temperature ranges, heating and cooling periods are evaluated separately. Figure 32 shows an overview of both seasons.

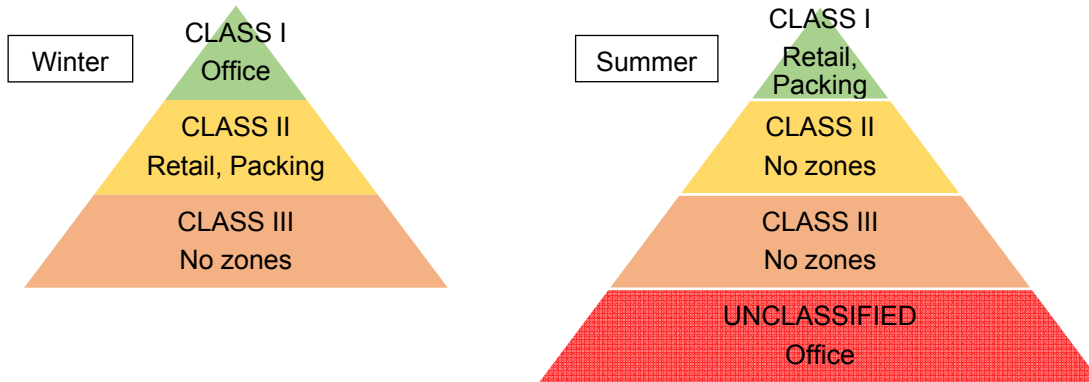

Figure 32 - Energy classification

From the evaluation of winter period it can be seen that the office zone falls into class I, and retail and packing falls into class II. For detailed information see Figure 85 to Figure 90.

For retail and packing areas, as seen by the temperature ranges in Figure 33 and Figure 34, the class II is due to an overheating of the indoor environment. That means that, with a more careful regulation, both the retail and packing zones might be able to be classified in the energy class I.

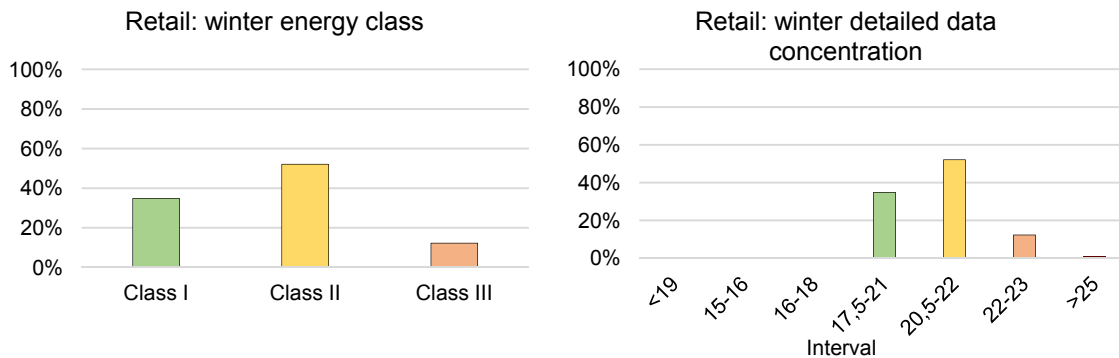

Figure 33 - Retail zone: winter energy classification

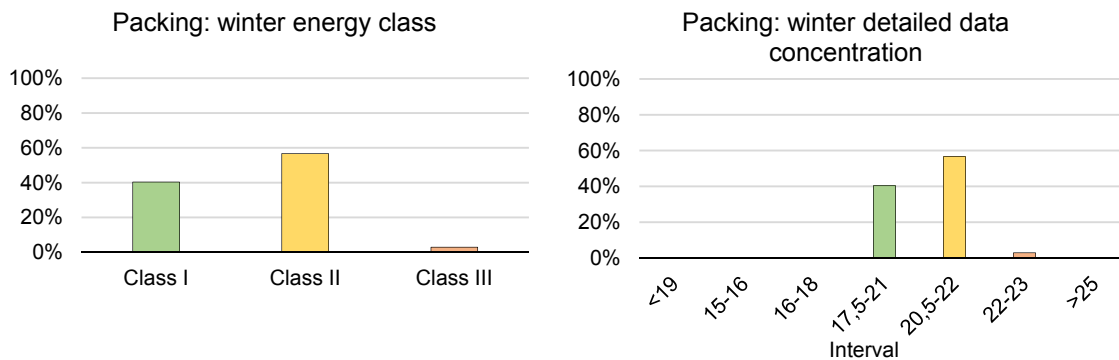

Figure 34 - Packing zone: winter energy classification

As for the evaluation of winter period, the office falls in class I, and for the summer period the considerations are different.

Considering the charts for the office zone in summer conditions, Figure 35 (retail and packing zone are reported from Figure 85 to Figure 90) it can be noted that the energy consumption is higher than the maximum contemplated in the European Standard (EN 15251, 2007). Even in that case a better regulation can lead the office zone to save energy whilst increasing the energy class.

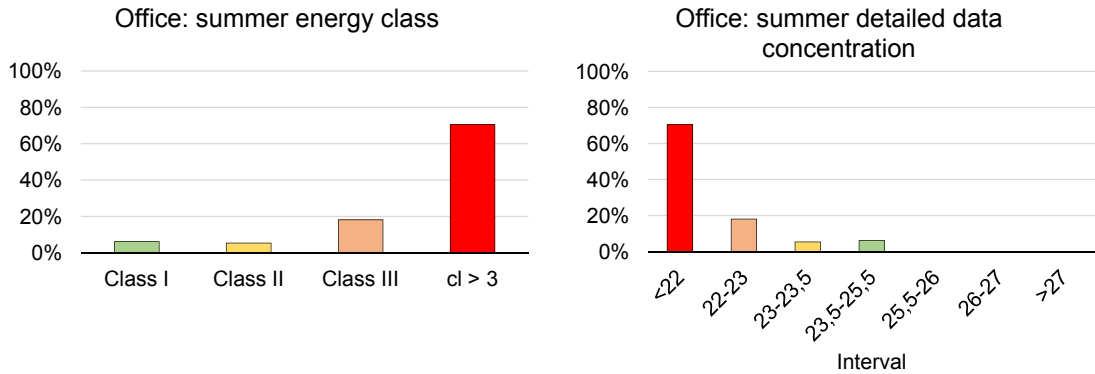

Figure 35 - Office zone: summer energy classification

Further consideration should be developed linking the previous energy analysis with the long period comfort 6.1.2, but this is not the purpose of the project and due to the rather rough split of cooling and heating period, this is left to possible future studies.

8.4 Conclusions on energy evaluation and building classification

Overall the common feature for all three zones is that, in most of the cases, zones are all overheated or overcooled. Because of that, a more careful regulation might reduce the energy consumption whilst increasing the energy class of the whole building.

A DCV system allows an adjustment of the airflow coherently with the building occupancy. Therefore, the airflow can fluctuate from a minimum value due to local laws and the designed set points. According with equation (10) it can be seen that that variation can significantly reduce the thermal capacity.

In Figure 27, Figure 28 and Figure 29 the thermal energy supplied to zones is compared to the electric energy used in fans and it is clear how much the fans absorption is important for the whole consumption of the building. Therefore, adding the possibility to reduce the fans power because of the adjustment of the airflow, the energy saving achievable with a DCV system seems much more interesting.

9 IDA ICE modelling

In order to evaluate the energy saving between an installed CAV system and theoretical DCV system the simulation model of the analysed Engelsons building was constructed. There were different scenarios modelled such as the existing system with more accurate regulation and numerous different ventilation systems.

In particular the accurate regulation (not considering the replacement or the installation of the different components such as dampers, variable speed fans, electronic controls, etc.) is the main change in upgrading from CAV to DCV.

IDA ICE software (developed by EQUA) was used for modelling and simulation.

The model that describes the analysed building during the built RYR and that has to be verified comparing the calculation developed in chapter 7 is from now on called “CAV_RYR” model.

The steps in the analysis that were considered are:

- 1- Build a model called CAV_RYR in order to verify the strength of the model with the collected data and analyses developed above;
- 2- Verify the model, modify it taking into account the changes in the installation over the years. In this step the weather data were also changed, the RYR were replaced with the IWEC2 data series used for energy calculation (CAV model);
- 3- Modify the regulation parameters of the installed and modelled system in order to simulate a VAV system (VAV model) and a DCV system (DCV model) always with the same indoor temperature set point.
- 4- Change the indoor temperature set point in order to evaluate the energy and economic expenses for the best indoor comfort (DCV class 1 model)t.

The comparison between the models will be done with energy and consequently economic focus.

9.1.1 IDA ICE – software description

IDA ICE is an innovative and trusted whole-year detailed and dynamic multi-zone simulation application for study of thermal indoor climate as well as the energy consumption of the entire building. (EQUA, 2014).

9.1.2 Model description

In the first step, the whole building was drawn in (SketchUp, 2013) and then imported as a model in IDA ICE Figure 36. In Figure 91 and Figure 92 there are the sections of two stages with different zones highlighted with the proper orientation.

Building envelope

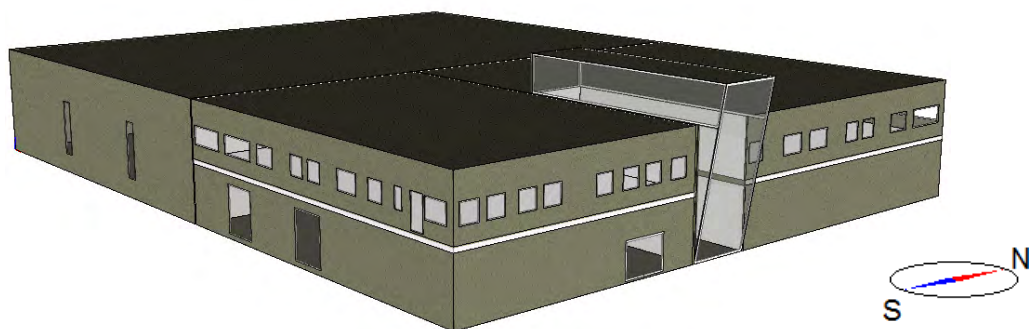

Figure 36 - Building envelope in IDA ICE

Due to the fact that only partial documentation is available (actual walls layers and windows are unknown; thicknesses and U-values are available), the standard walls included in the software are used whilst adapting the thickness of the layers in order to reach the known thickness and the desired U-value for each wall.

The windows in the model were selected from available models in the software library with the most similar characteristics to the actual windows in Engelsons building. There is no external shading due to sufficient shading by horizon or other surrounding buildings.

Table 12 recaps the features of the walls and windows used in the model.

Table 12 - Parameters of building envelope in the model

	Total U-value [W/(m ² .K)]	Layers	Thickness [m]	Heat Conductivity [W/(m.K)]	Density [kg/m ³]	Specific Heat [J/(kg.K)]
External walls	0,311		0,305			
		Render	0,010	0,800	1 800	790
		L/W concrete	0,245	0,036	20	750
		Insulation	0,050	0,036	20	750
		Render	0,010	0,800	1 800	790
Internal walls	1,734		0,120			
		Gypsum	0,025	0,220	970	1 090
		Air gap	0,070	0,390	1,2	1 006
		Gypsum	0,025	0,220	970	1 090
External floors	0,143		0,310			
		Chip Board	0,090	0,130	1 000	1 300
		Insulation	0,220	0,036	20	750
Internal floors	0,171		0,310			
		Floor coating	0,005	0,180	1 100	920
		Default wall structure	0,050	0,130	1 000	1 300
		L/W concrete	0,020	0,150	500	1 050
		Concrete	0,235	1,700	1 300	880
Roof	0,190		0,360			
		Insulation	0,180	0,036	20	750
		Concrete	0,180	1,700	2 300	880
Glazing		U-value	1,200	[W/m ² .K]		
		g-value	0,430	[%]		

Note: the buildings' long and width sides have two different U-values even if the thickness is the same. Because of that, U-value was assumed as a baseline with an average value weighted on effective surface.
 $U_{tot} = (0,334 \cdot 640 + 0,305 \cdot 844) / (640 + 844) = 0,318$

In the software all the internal walls with the undefined zones are considered as adiabatic such as internal walls between the monitored area and warehouse and rented office.

Ground

As for the ground properties and the calculation of the thermal loss through it, the model described in European Standard (ISO 13370, 2007) was used as automatically assigned in the software.

Thermal bridges

In the model, for all thermal bridges, the typical values suggested by the software are used. The list of thermal bridges is reported in Figure 93 in Appendix A.4.

Infiltration

As for the infiltration it was chosen to set the value to 0,5 ACH at pressure difference of 50 Pa. An internal algorithm adapts this value to the correct one taking into consideration the wind profile set as default urban.

Extra energy and losses

It considers all of the extra energy and losses in the air and water distribution system. The adopted parameters are reported in Figure 84 in Appendix A.4.

HVAC system

In this model only the ventilation system was simulated. Because of that, the heat pump providing thermal capacity to the different coils is not simulated.

As power plant was assumed that the default system included in the software, such as a standard boiler and a standard chiller (both of infinity capacity) were used in order to ensure that the coils have enough thermal capacity to provide the required energy.

AHU was constructed as in Figure 37. According to the design documentation the set point for supply air temperature is fixed to 18,5°C as a constant set point and the temperature increase for air through the fans to 1°C.

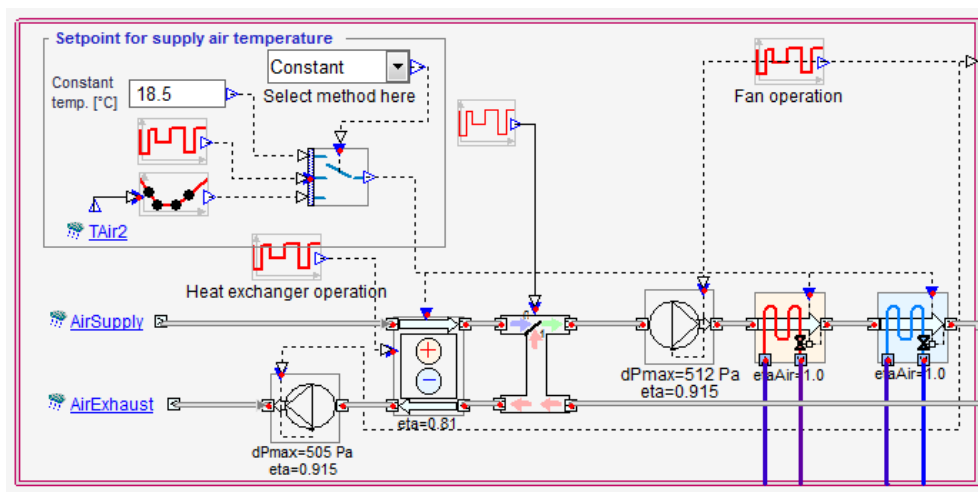

Figure 37 - Diagram of AHU TA/FA2 from IDA ICE model

In addition, according to the analysis in 4.2.2, the regulation for fans, bypass section and heat exchanger (coils and recovery) is assumed in a model to be always on (on = fresh air, off = recirculation).

Zones parameters

All zones are characterized as a constant air volume system.

Table 13 shows an overview of ventilation parameters used in the different zones in the model.

Table 13 - Ventilation parameters

Ventilation type	Minimum temperature [°C]		Maximum temperature [°C]		Mechanical airflow [l/(s.m ²)]	
	Occupied	Unoccupied	Occupied	Unoccupied	Occupied	Unoccupied
Office CAV	21,5	21,5	21,5	21,5	1,58	1,58
Retail CAV	21,0	20,0	21,9	23,9	2,03	2,03
Packing CAV	20,6	20,1	22,1	24,1	0,34	0,34

Referring to Table 13, minimum temperatures and maximum temperatures are the temperatures for heating signal and cooling signal respectively.

Because there is no further information, these temperatures were evaluated as the mean value of the secondary air in the active beams (where present) and the record available for the indoor air in the retail during both occupancy and unoccupancy periods in the operation mode heating

and cooling. Occupancy and unoccupancy periods, heating and cooling periods are defined respectively in Table 9 and chapter 7.3.

Occupancy period takes into account the daytime only, differently unoccupancy period take into account both daily and nightly times that make the records not comparable. In fact during night time in the Swedish summer period the outdoor temperature is unlikely to rise above 15°C, therefore a lower temperature is recorded compared to the days, as observed in Figure 81.

Because of that, the unoccupancy temperature set point for the maximum temperature, is chosen to be two degrees higher than the occupancy one (according to the night mode functioning) in order to take into account that observation.

Room components

According the design documentation, where present, active beams are constructed in the model.

Input data for each active beam is the real manufacturing values such as airflow, power at design airflow, power at zero airflow, ΔT (coolant-air zone) at max power, ΔT (coolant) at max power. For each different active beam these values were evaluated with the software (Swegon, 2014).

As for retail and packing zones the extra equipment installed in a second time, such as split and fan coils, were not included in the model. In the evaluation of the thermal capacity and energy from the recorded data, chapter 7, because of where no information on the functioning of the additional equipment, all the thermal energy was considered given by the airflow.

So, for coherence between calculations and model, initially the extra equipment was not considered, but will be added in the second step.

Internal loads

As for internal loads, there is the possibility to insert separate time schedules for occupancy, equipment and lightning with the specific profile for weekdays, Saturdays and Sundays with public holidays.

The information for time schedules is stated in Tables 8 and 9. Figure 38 shows the time schedule for occupancy, lightning and equipment used in the model. Where “0” is 0% of load, “1” is the 100% of load coupled with the specific type of occupancy, equipment or lightning.

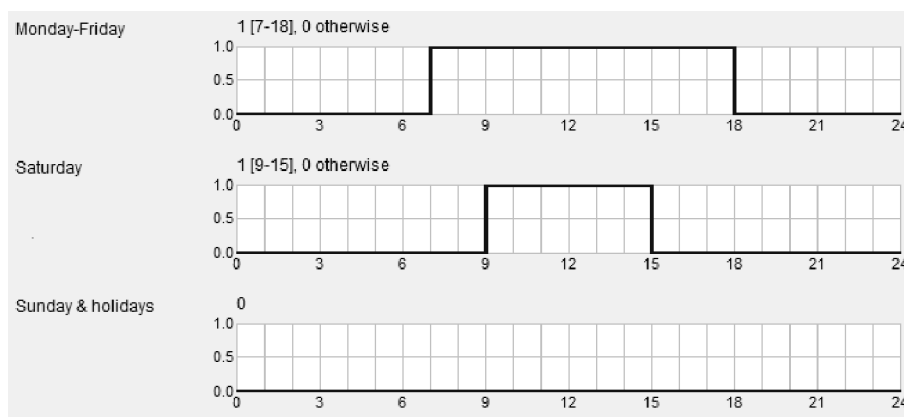

Figure 38 - Time schedule for occupancy, equipment and lightning

As for occupancy, it was chosen to use the maximum value of people for which the system was designed and value 30 l/s per person with values of CLO and MET according with European Standard (ISO 7730, 1994) was implemented.

The amount of equipment was assumed based on the evaluation of numbers of employees and on the observation of the equipment typically present in working places in Sweden. The value of 100 W was assumed as the average specific emissivity per equipment.

As for lightning, the number of units were taken from technical documentation. The consumption of 20 W per light was assumed because of the fact that all lights are neon.

In Table 14 there is a summary of the total values for the internal loads adopted in the model.

Table 14 - Internal loads

	Occupancy			Equipment		Lightning	
	Nr.	clo	met	Nr.	Specific emitted heat [W]	Nr.	Specific emitted heat [W]
Office ground floor	3	0,96±0,25	1,2	5	100	3	20
Office first floor	22	0,96±0,25	1,2	20	100	40	20
Retail	30	0,61±0,25	1,6	5	100	40	20
Packing	6	1,14±0,25	1,6	10	100	40	20

Internal mass

The surfaces of internal walls were measured from drawings. As for the furniture, values provided by internal database are being used.

As for the internal mass the values as stated in Table 15 were considered.

Table 15 - Internal mass

	Walls		Furniture	
	Surface [m ²]	Convective heat transfer coefficient [W/m ² .K]	Surface [m ²]	Convective heat transfer coefficient [W/m ² .K]
Office ground floor	31	1	9	6
Office first floor	433	1	84	6
Retail	-	-	88	6
Packing	-	-	102	6

Weather and location

The weather profile built in chapter 5.5 called RYR referred to Torup A (Lat. 57,02°N, Long. 13,07°E) was loaded into the software. The outdoor weather profile based on RYR consists of parameters such as ambient temperature, relative humidity, wind velocity, direct and diffuse solar radiation.

The solar irradiation was downloaded from the (SMHI, 2014) that consists of global and direct irradiance measured in watts on square meters for the station Torup A.

As for wind velocity, the wind profile included in the climate file referred to Gothenburg S ave was used because Gothenburg is based on the coastline as well as Falkenberg.

To calculate the diffuse radiation, the procedure described in the standard (UNI 8477) was used. The procedure is described in the following equations from (21) to (27) which allow the diffuse solar radiation to be calculated if the global irradiance is known.

$$K=0,881-0,972K_T \quad (21)$$

$$K=H_{diff}/H_{glob} \quad (22)$$

$$K_T=H_{glob}/H_o \quad (23)$$

$$H_o=I_o \cdot \sin(HS) \quad (24)$$

Where:

H_{diff}	diffuse irradiance on a horizontal surface on the ground	[W/m ²]
H_{glob}	global irradiance on a horizontal surface on the ground	[W/m ²]
H_o	horizontal extra-atmospheric irradiance	[W/m ²]
I_o	extra atmospheric irradiation on vertical surface	[W/m ²]

$$I_0 = 1367 \left[1 + 0,033 \cos \left(\frac{360n}{365,25} \right) \right] \quad (25)$$

$$\sin(HS) = \sin(LAT) \sin(\delta) + \cos(LAT) \cos(\delta) \cos(AH) \quad (26)$$

$$\delta = 23,45 \sin \left[\frac{360}{365} (284 + n) \right] \quad (27)$$

Where:

δ	solar declination	[°]
HS	solar height angle	[°]
AH	hourly angle	[°]
n	number of the day in the year	

9.1.3 Result and verification of the model

The model analysis is focused on the energy evaluation keeping indoor temperature set points, in order to focus on possible energy savings in the upgrading from CAV to DCV system.

Comparing the monthly specific energy result from the simulation and the result of the analysis of chapter 0 for the different zones the following can be drawn from Figure 39, Figure 40 and Figure 41. In these graphs it can be seen that the overall profile is respected in the whole year even if there are some months where the differences are remarkable, e.g., in month August and October.

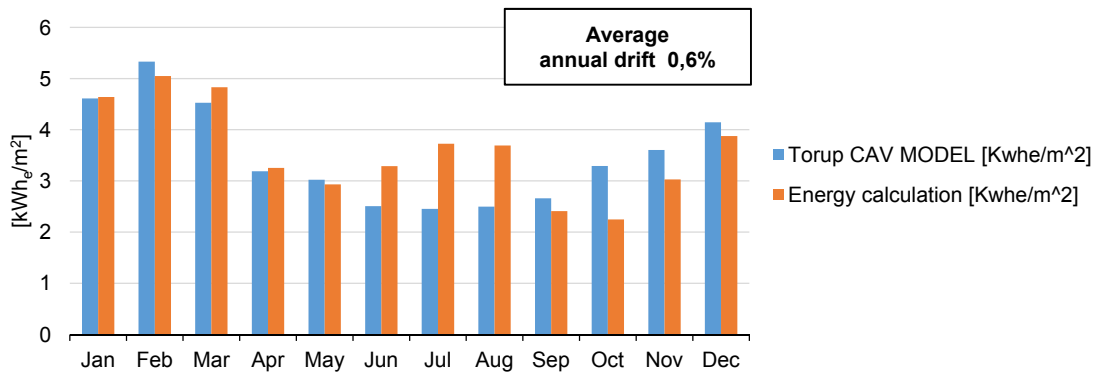

Figure 39 - Office zone - comparison between analysis on recorded data and model on IDA ICE

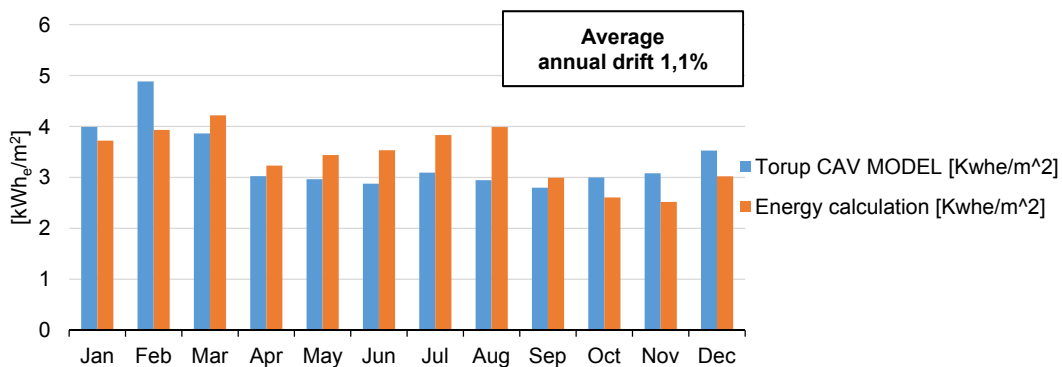

Figure 40 - zone - comparison between analysis on recorded data and model on IDA ICE

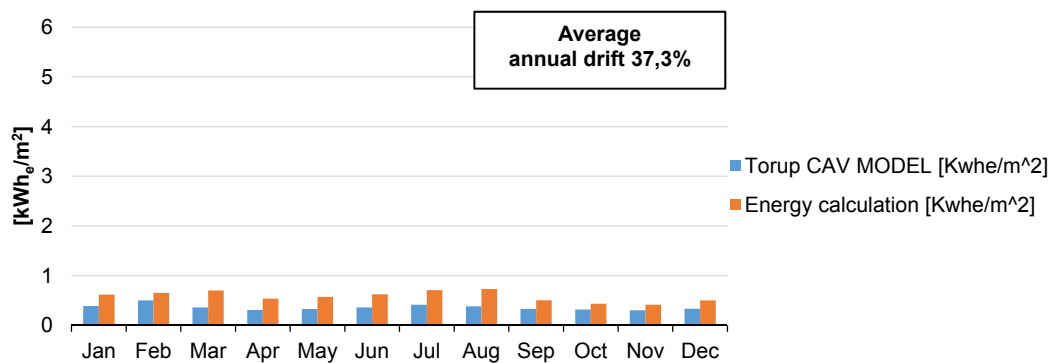

Figure 41 - Packing zone - comparison between analysis on recorded data and model on IDA ICE

In addition it can be seen that the model in the office and retail zones shows a higher energy demand compared to the calculated values in the summer months (June, July, August) coherently with the analysis done in chapter 7. As for the packing zone, Figure 41, an average value of annual spread of 37,3% seems high, but it should be noted that this is a relative value.

For further information on monthly spread between the calculated demand of energy and the modelled ones, see Table 48, Table 49 and Table 50, included in Appendix A.4.

Referring to Figure 42 it can be noted that the influence of the packing zone is only 6 % of the total demand of energy in the analysed sub-system.

Because of that, the values referring to all the errors to the whole consumption can be found in Table 16.

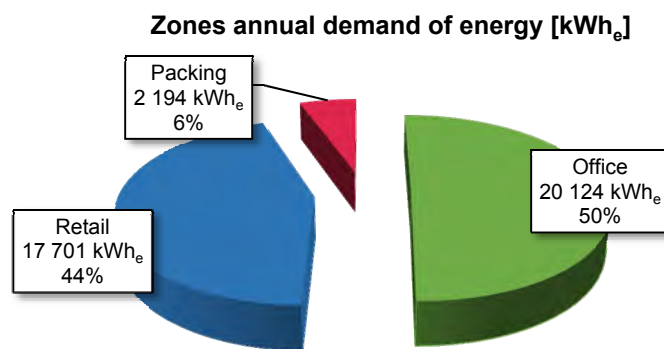

Figure 42 - Influence of single zones in the total calculated consumption

Table 16 - Absolute influence of single zones

Zone	Influence on the total demand of energy
Office	0,3%
Retail	0,5%
Packing	2%

Because all the errors between simulations and surveys in absolute terms are quite small and because of the fact that the only zone without additional equipment, the office zone, has a relative error of the 0,6% and an absolute one of 0,3% of the model can be assumed as verified.

In addition, looking to the indoor temperature in the different zones it can be noted that for the office zone, Figure 43 and the retail one, the indoor temperature set point is respected

during the whole year. On the contrary, for the packing zone, Figure 44, the indoor temperature set point is not reached, as in this stage of a model there is no additional fan coils for the heating and the packing area is designed in a model based on original design as a stock area.

The detailed analysis can be found in Table 48, 49 and 50 in Appendix A.4.

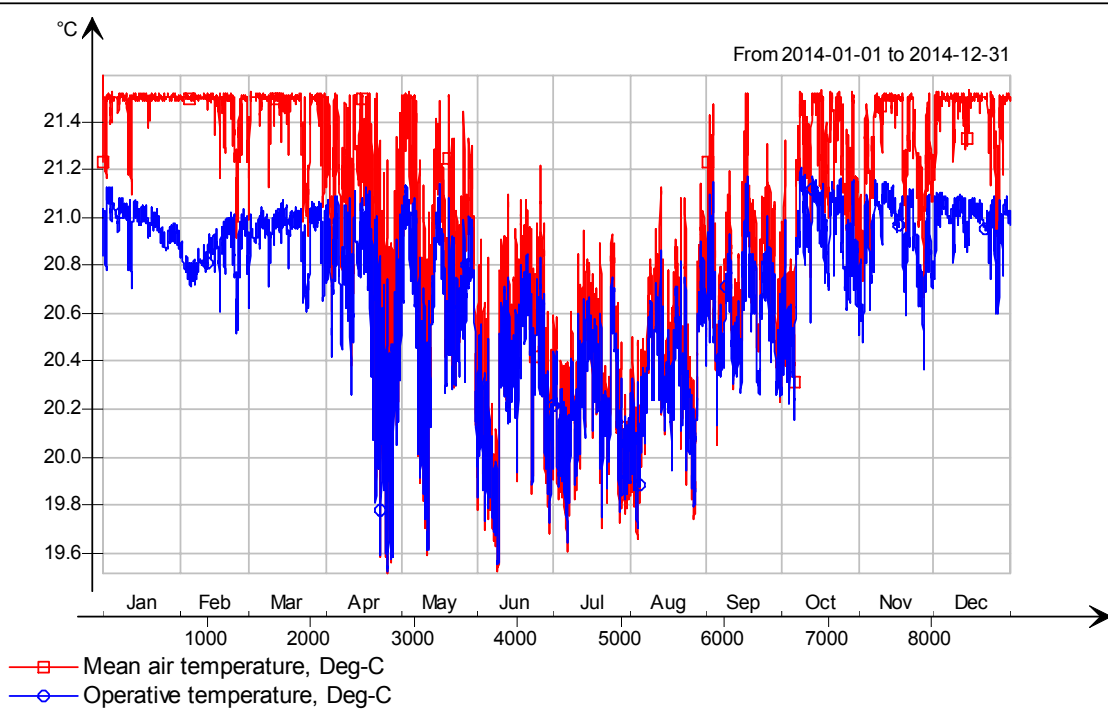

Figure 43 – Indoor temperature profile for office zone, IDA ICE model

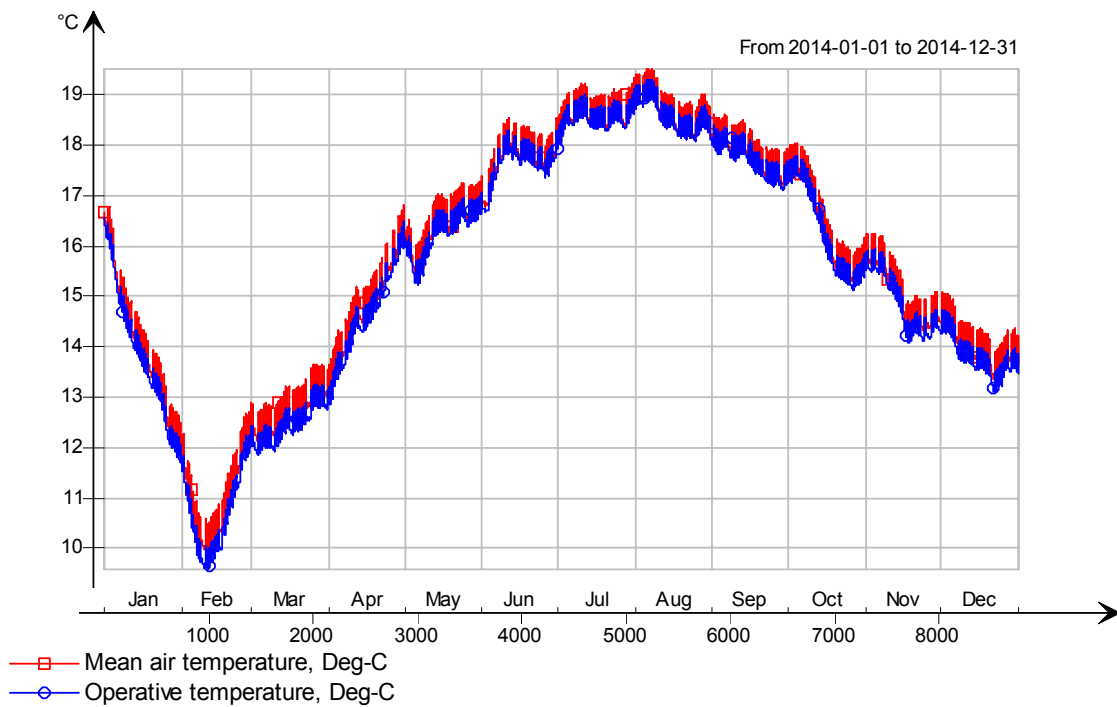

Figure 44 – Indoor temperature profile for packing zone, IDA ICE model

9.1.3.1 Verification of the standard Weather (IWEC2 data)

In order to make a real picture of the building in the average climate zone, it is necessary to make other simulations using desired location and its respective climate data represented by Test Reference Year (TRY).

Unfortunately, the TRY for Falkenberg, the location where the building is situated, is not available.

Looking at the locations available in the software database, the choice is between two locations for which the International Weather for Energy Calculations (IWEC2) weather data are available: Gothenburg (approximately 100 km north from Falkenberg) and Ängelholm (approximately 75 km south from Falkenberg).

The result of the analysis done for these two locations, reported in Figure 45, shows a good fit for the profiles with an annual average error of 1%.

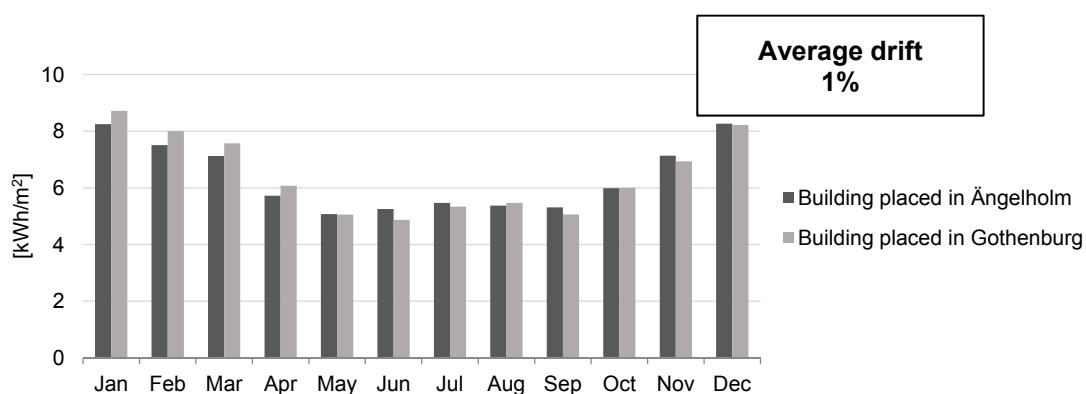

Figure 45 - Comparison on the energy demand for two different locations (based on IWEC2 data)

As a result, the weather data for Gothenburg can be used in IDA ICE instead of Ängelholm.

In the following analysis Ängelholm was taken as a location in IDA ICE models because it is the closest to the real site.

In addition, because the spread between the results of the analysis in Ängelholm and Gothenburg is 1%, it is reasonable to take into consideration in the following chapter 9 proper also for Falkenberg, which is at half way between the two sites.

10 Energy evaluation

The energy saving that can be achieved using a DCV system compared to CAV system is described in this chapter.

The CAV_RYR model was modified in order to show a more recent picture based on the updating of airflow and the addition of the extra fan coil heaters to the packing area and additional cooling fan coils to the retail consistent with the description of chapter 4.

In addition, the DCV system with a new indoor temperature set points was evaluated to improve the comfort conditions of the building according to the European Standard (EN 15251, 2007) and improvement of the energy class of the monitored zones coherently with the considerations done in paragraphs 6.1.2 and 7.3.2.

The economic analysis was performed considering the payback time of improvement from a CAV to DCV system.

The simulations and results calculated for a building placed in Ängelholm can be considered to be consistent also for the same building placed in Falkenberg because of the observations stated in paragraph 8.1.3.1.

10.1 Scenario - CAV

As described in chapter 4, several improvements were applied to the building in the retail zone, and the packing zone was adapted to the amount of people present.

In this chapter, the previous CAV_RYR model is improved in order to simulate the actual building situation with all improvements done during the years. The parameters described in chapter 8.1.2 are still valid; the airflow is increased in the packing zone to 300 l/s and an additional fan coil heater of 10 kW is applied.

In addition an ideal cooler of 10 kW was added in the retail zone in order to simulate the effect of the fan coils. The capacity of 10 kW for heater and cooler was chosen in order to be able to fully cover the supply power of demanded energy.

Table 17 - Indoor temperature set points in and model updates

Ventilation Type		Temp. min [°C]		Temp. max [°C]		Mechanical airflow [l/s]		Power [kW]
		Occupied	Unoccupied	Occupied	Unoccupied	Occupied	Unoccupied	
Office	CAV	21,5	21,5	21,5	21,5	725	725	
Retail	CAV	21,0	20,0	21,9	23,9	900	900	
Packing	CAV	20,6	20,1	22,1	24,1	475	475	
Retail additional cooling system				Fan coils				10
Packing additional heating system				Fan coils				10

The results of the simulation of a system with these improvements (Figure 46, Figure 47 and Figure 48) show the comparison between a validated CAV_RYR model, chapter 8.1.3 for the different zones and a new model, called from now CAV model with implemented changes based on actual situation in Engelsons building.

In both Figure 46 and Figure 47 you can see a reduction of the energy demand for both the office and retail zones and, in Figure 48, a significant increase of energy demand for the packing zone consistent with the considerations done in Figure 41.

The reduction of energy demand in office and retail zones is consistent with the increase of energy demand in the packing zone.

In fact, to reach the indoor temperature set point in the packing zone without extra equipment, the heating load came from the primary air only. Because of that, the total airflow was handled in the central section and then, in the energy evaluation, split into the three zones increasing the heating load even in the office and retail zones.

In addition, in the same Figure 46, Figure 47 and Figure 48 it can be noted that the temperature profiles for all three zones are now reached and sustained at a respective level.

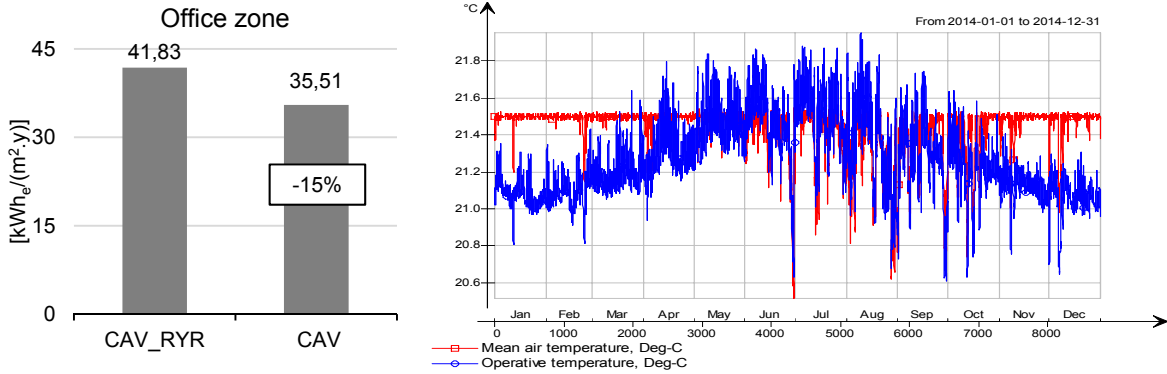

Figure 46 - Office zone: comparison between CAV_RYR model and CAV model including indoor temperature profile

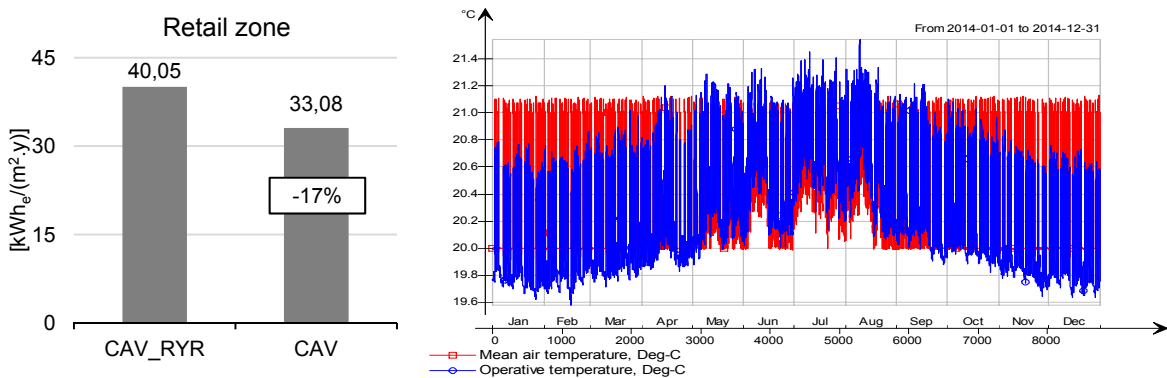

Figure 47 - Retail zone: comparison between CAV_RYR model and CAV model including indoor temperature profile

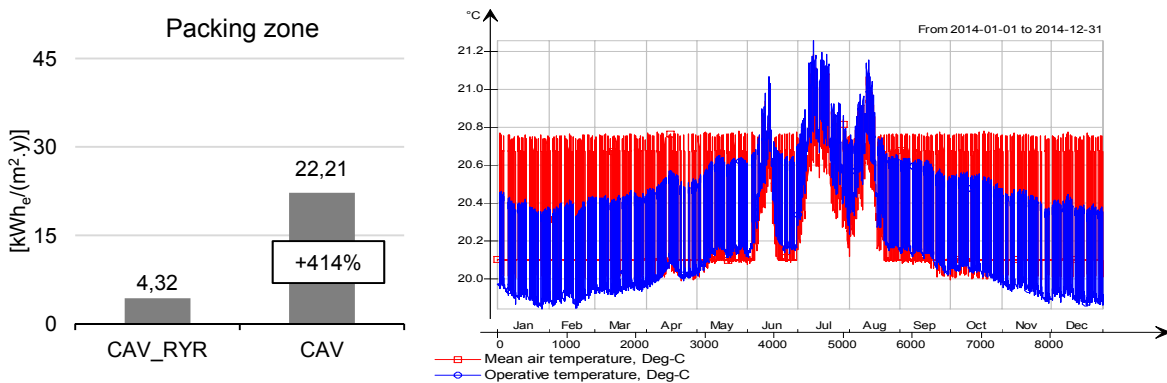

Figure 48 - Packing zone: comparison between CAV_RYR model and CAV model including indoor temperature profile

10.2 Scenario - VAV

As it became known from the analysis of the recorded data in chapter 5.4.2.3, the system is not performing as it should during the night, i.e. reducing SFP and allowing a temperature gap of $\pm 2^{\circ}\text{C}$ (cooling or heating mode) during the unoccupied period.

Because of that, the night mode is simulated in the model by changing the regulation of the components in AHU and changing the indoor temperature set points for each zone as described in Table 18.

For the packing zone it is assumed that air volume equals to the design one with a minimum of fresh air of $0,35 \text{ l/(s}\cdot\text{m}^2)$ according to the Swedish building regulation (Boverket, 2011). That value is based on national building regulation and it represents the minimum value for fresh air.

For that reason, this system might be defined as a variable air volume system (VAV).

Table 18 reports the airflow for the different zones along with the ratio between the minimum and the design airflow in the air handling unit.

Table 18 - Minimum value of airflow for the zones

	Design airflow [l/s]	Minimum allowed airflow [l/s]	Ratio
Office	725	168	
Retail	900	154	
Packing	475	177	
Total	2 100	500	0,238

Due to the fact that the airflow control is at the central level, exhaust fan and bypass are controlled by the schedule in Figure 49, with which, during the unoccupied period, according to Table 18, the functioning is been cut to 23,8%.

This model represents a simple variable air volume system and, because of that, from now on it will be called the VAV model

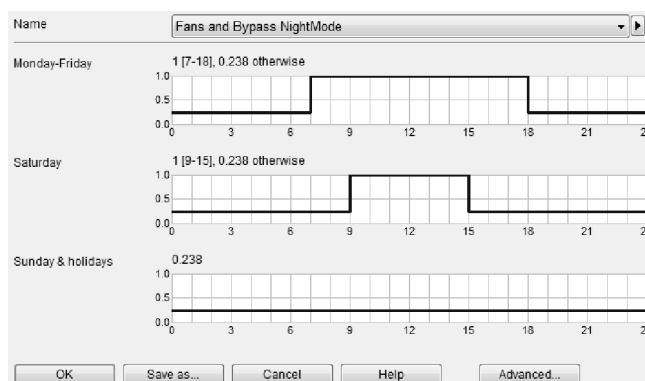

Figure 49 - Schedules for bypass and fan

Table 19 - Settings for VAV model

Component	Description	Schedule
Exhaust fan	Switched off during the unoccupancy period	Figure 47
Supply fan	Always on to guarantee the heating or cooling also during the unoccupancy period	Always on
Bypass section	Switched on during the unoccupancy period	Figure 47
Rotary heat exchanger	Always on in order to recover the maximum quantity of energy	Always on
Indoor temperature set point	For each zone unoccupancy period set point Temp. min -2°C ; Temp. max +2°C	Table

Ventilation	Type	Temp. min [°C]		Temp. max [°C]		Mechanical airflow [l/s]		Power [kW]
		Occupied	Unoccupied	Occupied	Unoccupied	Occupied	Unoccupied	
Office	VAV	21,5	21,5	21,5	21,5	725	168	
Retail	VAV	21,0	20,0	21,9	23,9	900	155	
Packing	VAV	20,6	20,1	22,1	24,1	475	177	
Total airflow						2100	500	
Retail additional cooling system				Fan coils				10
Packing additional heating system				Fan coils				10

10.3 Scenario – DCV

As for the DCV model, now known as the DCV, a variation has been allowed for the airflow from the minimum legal of 0,35 l/(s.m²) to a maximum of the design value for each zone, Table 18.

In addition, the software allows a choice between several control methods for the airflow variation: on the CO₂ control, humidity control, schedule on the people presence, etc.

The latter method has been chosen by considering a daily occupancy profile Figure 50 and Figure 51, based on (Johansson, 2005), profile with an occupancy rate of the 50%. Occupancy days and hours are based on Table 8, Table 9 and Figure 38.

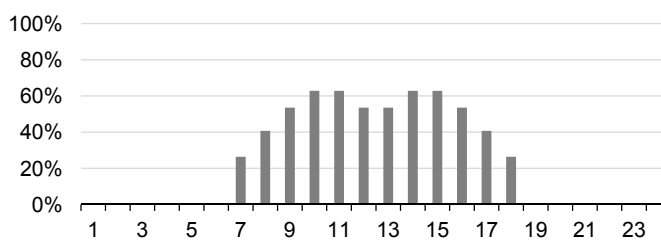

Figure 50 - Work days occupancy profile DCV

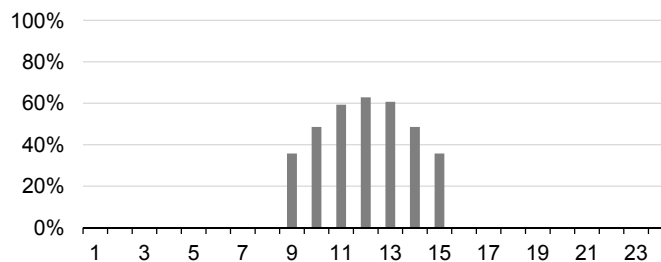

Figure 51 - Saturdays occupancy profile DCV

Note: the occupancy profile for the retail zone might be sensibly far from the adopted one and represented in Figure 50 and Figure 51. It should present peaks during the lunch break and during the late afternoon.

The same consideration with other profiles can also be done for the packing zone.

The choice to use the same profile for all three zones is to keep the same ratio between the supply airflow for the single zone and the total handled by the air handling unit.

Note: The occupancy rate of 50% may not correspond to the real occupancy rate. Further studies would be needed.

Table 20 – Settings for DCV model

Ventilation	Type	Temp. min [°C]		Temp. max [°C]		Mechanical airflow [l/s]	Power [kW]
		Occupied	Unoccupied	Occupied	Unoccupied		
Office	DCV	21,5	21,5	21,5	21,5	Occupancy profile	
Retail	DCV	21,0	20,0	21,9	23,9	Occupancy profile	
Packing	DCV	20,6	20,1	22,1	24,1	Occupancy profile	
Retail additional cooling system				Fan coils			10
Packing additional heating system				Fan coils			10

The DCV system has been simulated in order to keep the same indoor temperature set points and with the same settings of the VAV model (Table 19).

In addition, another scenario was considered.

10.4 Scenario – DCV class I

Once the DCV system was modelled inside the building, the indoor temperature set points were modified inside the different zone according with European Standard requirements as represented in Figure 63 in Appendix A.3 (EN 15251, 2007) in order to increase the class of the entire building and the thermal comfort in it according with the considerations done in chapter 7.3.2.

The set points for the different zones in this simulation, from now called DCV class I are reported in Table 21. Class I refers to energy class of a building as described in European Standard (EN 15251, 2007).

Table 21 – Settings for DCV class I model

Ventilation	Type	Temp. min [°C]		Temp. max [°C]		Mechanical airflow [l/s]
		Occupied	Unoccupied	Occupied	Unoccupied	
Office	DCV class I	22	20	24,5	26,5	Occupancy profile
Retail	DCV class I	19	17	23	25	Occupancy profile
Packing	DCV class I	19	17	23	25	Occupancy profile

As the set point for the occupancy period has been taken as the average value considered in Figure 63 included in European Standard (EN 15251, 2007) for every considered zone in order to be sure that the zone is included in class I favouring in this way the indoor thermal comfort.

10.5 Sequence and comparative analysis

All the scenarios described above are compared by one another in order to have an evolution profile

in the possibility of implementation of a ventilation system (sequence analysis). After that, the scenarios are coupled in order to have the possibility of comparison for the energy expenses in the choice of a ventilation system instead of the other (comparative analysis).

Table 22 summarizes the four scenarios taken into account in the energy evaluation and consequently in the next economic evaluation.

Table 22 - Simulation scenarios

	Name	Description	Parameters
Scenario 1	CAV	Actual state of the building	Table 17
Scenario 2	VAV	CAV system with night mode switched on	Table 19
Scenario 3	DCV	Demand controlled ventilation system with 50% occupancy rate and the night mode switched on	Table 19, Figure 48, Figure 49
Scenario 4	DCV class I	DCV with zones' set point for reach the class I building according with (EN 15251, 2007)	Table 19, Table 21, Figure 48, Figure 49

Due to the simulations of Table 22, Figure 52 shows the results for the overall consumption in the four speculated scenarios.

Sequential analysis

Figure 52 shows the sequential analysis where the sequential reduction of the overall consumption can be seen in the improvement of the installed ventilation system.

The results show a progressive decrease of the energy used for the entire conditioning system due to the improvement of the ventilation system only. The split of the overall consumption in heating, cooling and ventilation (energy for the air circulation) is fundamental for the economical analysis and the evaluation of the payback period in the installation of a ventilation system instead of another.

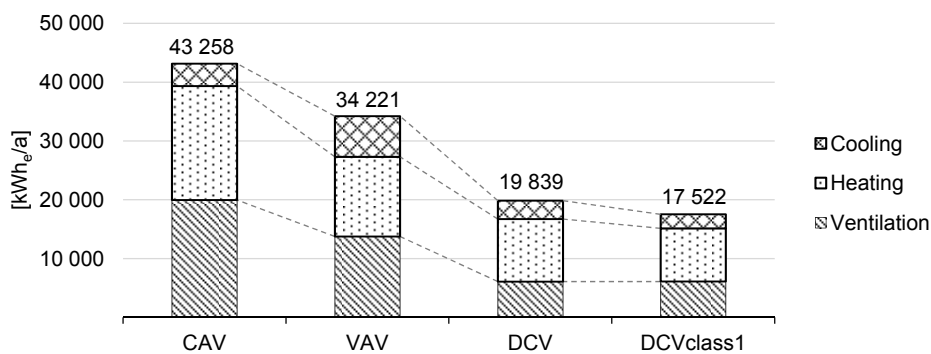

Figure 52 - Overall annual energy consumption for scenarios

Comparative analysis

In order to compare the energy expenses in the choice of one ventilation system to another, the scenarios were coupled as shown in Table 23, comparing the values of each simulation and providing information about the energy savings.

Table 23 - Overall annual energy consumption and savings

Scenario	Overall consumption [kWh _e /a]	
CAV	43 258	
VAV	34 221	
DCV	19 839	
DCV class I	17 522	
System improvement scenario	Energy saving	
	[kWh _e /a]	[%]
CAV → VAV	8 936	20,7%
VAV → DCV	14 383	42,0%
CAV → DCV	23 319	54,0%
DCV → DCV class I	2 316	11,7%

Zooming into the single zones and evaluating the percentage of the overall energy savings are shown in Table 24 where it is revealed that the operation in night mode allows an annual average saving higher for the office zone than for the others, 28% instead of 14% for the retail and 17% for the packing. On the contrary, for the DCV system the saving is higher for the retail zone if is considered only the system improvement scenario VAV → DCV and almost equal to the office if the upgrade is considered CAV → DCV.

As for the comparison between the DCV → DCV class I an increase in the demand of energy can be seen for the office zone and a reduction for the zones retail and packing.

Table 24 - Zone annual mean percentage of energy reduction

System improvement scenario	Annual mean percentage of energy reduction		
	Office zone	Retail zone	Packing zone
CAV → VAV	28%	14%	17%
VAV → DCV	40%	50%	34%
CAV → DCV	57%	57%	45%
DCV → DCV class I	-11%	28%	23%

Detailed information on the monthly energy savings for the different zones are reported in Appendix A.4. Figure 102 and Table 52 for the office zone, Figure 103 and Table 53 for the retail and Figure 104 with Table 54 for the packing zone.

10.5.1 Detailed energy analysis

The overall energy in a HVAC system is composed by energy for ventilation absorbed by fans, energy for heating and cooling.

Because of that, in this section, the overall savings in the different simulated scenarios have been split into the main parts in order to evaluate separately the influence of fans, heating and cooling on the savings.

Here after are reported the graphs and considerations for each system improvement scenario:

- From CAV to DCV: Figure 53
- From VAV to DCV: Figure 54
- From DCV to DCV class I: Figure 55

System improvement scenario CAV → DCV

From CAV to DCV, the model shows an overall saving of 54% in the energy consumption which amount to 23 319 kWh_e/a. That saving is composed by a 59% saving in the fan consumption, 38% in the energy for heating and 3% for cooling.

With reference to Figure 53, it can be noted that the energy for fans is reduced to 13 875 kWh_e/a, equal to a reduction of 69,5%.

For the heating and cooling the comparison between the two considered scenarios shows a reduction of 8 747 kWh_e/a, corresponding to 45% in the heating energy, and 697 kWh_e/a, equal to 18% for the cooling energy.

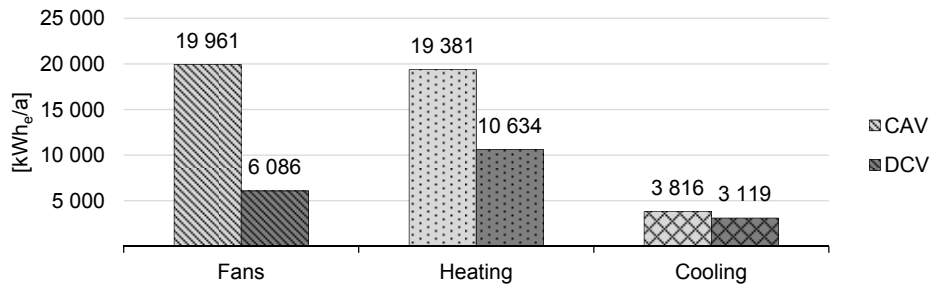

Figure 53 - Detailed energy reduction in scenario CAV → DCV

Detailed information for the different zones is reported in Appendix A.4 with Figure 105, Figure 106 and Table 55 for the office zone, Figure 111, Figure 112 and Table 58 for the retail zone and Figure 117, Figure 118 and Table 61 for packing zone.

System improvement scenario VAV → DCV

In a scenario from VAV to DCV the same considerations can be done as for the previous scenario. In this analysis the VAV model is 34 132 kWh_e/a and DCV model is 19 839 kWh_e/a, and this change from VAV to DCV represents overall energy saving of 14 293 kWh_e/a (or 42% respectively).

The savings of 42% is composited from savings from: cooling (26%), heating (20%) and fans (20%). This is based on savings of electrical energy. The detailed split of energy going to fans and heating and cooling can be found in Figure 54.

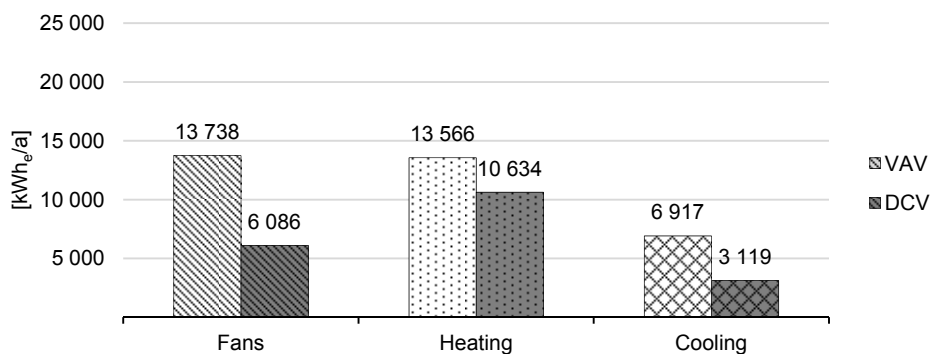

Figure 54 - Detailed energy reduction in scenario VAV → DCV

In this system improvement scenario, VAV → DCV, a higher influence can be seen in the reduction of the cooling energy compared to CAV → DCV: 20% instead of 3%. That amount of saving in reality is due to an increase in the consumption from 3 816 kWh_e/a to 6 828 kWh_e/a in the energy for cooling in the upgrade from a system CAV to a system CAV with the night mode operation switched on.

Detailed information for the different zones is reported in Appendix A.4 with Figure 107, Figure 108 and Table 56 for the office zone, Figure 111, Figure 114 and Table 59 for the retail zone and Figure 119, Figure 120 and Table 62 for packing zone.

System improvement scenario DCV → DCV class I

The class I for the different zones is verified taking some temperature profiles in random weeks during the analysis time and checking that the temperatures are included in the temperature gap considered from European Standard (EN 15251, 2007).

As visible in Figure 55, with a more accurate regulation of the indoor temperature set points in the zones an additional energy saving of 12% is reached due to a decrease of a 15% in the energy for heating and a 24% in the cooling energy.

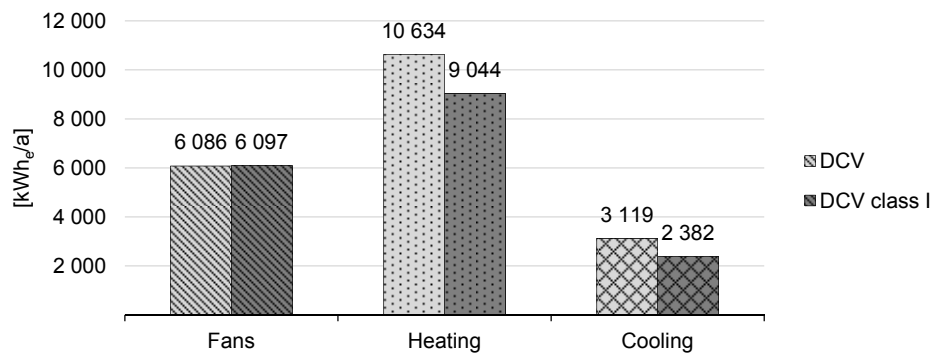

Figure 55 - Detailed energy reduction in scenario DCV → DCV class I

Detailed information for the different zones are reported in Appendix A.4 with Figure 109, Figure 110 and Table 57 for the office zone, Figure 115, Figure 116 and Table 60 for the retail zone and Figure 121, Figure 122 and Table 63 for packing zone.

Focusing on the zone consumption, Table 25 shows an overview of the simulated energy for ventilation, heating and cooling.

Table 25 - Zone energy consumption in scenario DCV → DCV class I

	Office			Retail			Packing		
	DCV [kWh _e /a]	DCV class I [kWh _e /a]	Saving [%]	DCV [kWh _e /a]	DCV class I [kWh _e /a]	Saving [%]	DCV [kWh _e /a]	DCV class I [kWh _e /a]	Saving [%]
Fans	2101	2105	0%	2608	2613	0%	1377	1379	0%
Heating	3924	5266	-34%	2544	930	63%	4166	2848	32%
Cooling	1333	822	38%	1172	1021	13%	614	539	12%

Comparing the results in Table 25 with what came up from chapters 6.1.2 and 7.3.2 it can be seen that for the office zone a 34% increase is required for the heating energy consistent with Figure 20 which shows a cool discomfort during the whole year.

A decrease of the cooling energy is also marked up consistent with Figure 35 that shows that the office zone owns to a class that is out of the classification suggested from the European Standard because of an overcooling of the zone.

Differently for retail and packing zones, according with Figure 33 and Figure 34 where the main cause of the class II for these two zones is attributed to the overheating of the zones, the model suggests a decrease in the heating energy.

The model also shows a slight reduction in the cooling energy for both retail and packing zones.

Conclusion and considerations

Table 26 shows an overview of the energy savings obtained in the comparative analysis for the different simulations relatives to the considered system improvement scenarios.

Table 26 - Overview of energy saving in system improvement scenarios

System improvement scenario	Energy saving							
	Overall		Heating		Cooling		Ventilation	
	kWh _e /a	%	kWh _e /a	%	kWh _e /a	%	kWh _e /a	%
CAV → VAV	8 827	20,5	5 815	30	-3 012	-79	6 223	31
VAV → DCV	14 293	41,9	2 932	21,6	3 709	54,3	7 652	55,7
CAV → DCV	23 120	53,8	8 747	45,1	697	18,3	13 875	69,5
DCV → DCV class I	2 317	11,7	1 590	14,9	737	23,6	-11	0,0

It is particularly important to split the energy saving between ventilation (fans), heating and cooling energy. That because fans are always powered by electric source, differently is for the thermal capacity that can be produced in several ways.

In the analysed system both fans and thermal are powered by electric sources respectively directly and by heat pump.

Now, if the thermal capacity was produced differently, e.g. district heating and chiller, the percentage of energy reduction for the aim, ventilation, heating or cooling was constant, but the differences in the production went to affect the economical evaluation because of the different efficiency of the production and price for the different sources.

Because of that the economic evaluation will be focused on the actual production system, such as a ground coupled double effect heat pump with COP = 4,85 and EER = 3,85 and an hypothetic scenario, based on the usual Swedish convention of district heating for heating source and chiller for cooling.

Note: the results reported in this chapter are valid for this specific example characterized by an occupancy profile of Figure 50 and Figure 51 and occupancy rate of 50%.

The occupancy rate affects significantly the results of the energy simulation and, because of that, further investigation would be needed for the occupancy profiles for the different aim of the spaces.

That could also lead to a smarter and wiser management of the airflows in order to reduce the size of the different components of the system.

11 Economic evaluation

It is routine in an economic evaluation to evaluate the life cycle cost (LCC), defined as whole life costing of a project including acquisition cost, facility management cost, and disposal cost (El-Haram, o.a., 2002). The 80% of a system life cost is “locked” in the purchase cost (Chao, o.a., 2004), the operating cost may be two or three times higher than purchase costs (El-Haram, o.a., 2003) and the demolition cost, often difficult to estimate, is the cost or gain of getting rid of assets after use.

Because of these difficulties in the evaluation of the demolition cost and due to the lack of accurate historical facility management costs for similar projects, the following economic evaluation was based on a simple payback period (PB). The payback period was evaluated for the system improvement scenarios of chapter 9.5 such as CAV-DCV, VAV-DCV, CAV-DCV class I and VAV-DCV class I were considered. In addition, an evaluation was done on the increase of the invested capital in a ten-years forecast in order to evaluate the profitability of the investment.

Before evaluating the payback period, the purchase and the operating costs (OC) were evaluated for each system scenario described in chapter 9. As seen in the same chapter 9, the energy consumption in a HVAC system is mainly composed of energy for ventilation (fans), heating and cooling. These different targets can be reached with several methods and sources.

Therefore, in the economic evaluation the energy production method cannot be ignored with the proper efficiency and the cost of the purchased energy source.

Because of that, for the evaluation of the operating costs and subsequently payback period in addition to the installed energy production system, another scenario was considered.

- **Installed HP:** ground coupled double effect heat pump with COP = 4,85 and EER = 3,85. In that case the only energy entering in the building is the electric source.
- **Scenario (DH-CH):** in that scenario was considered as heating source district heating (DH) and a 28 kW high efficiency class air-water chiller (CH) with a EER = 3,25 measured for an outdoor temperature of 35°C.

Note: All the considerations for the economic analysis are referred to the energy evaluation developed and described in chapter 0. In particular, for the DCV system an occupancy rate of 50% with occupancy profile of Figure 50 and Figure 51 was considered. These hypotheses can differ from the reality and, because of energy consumption is strictly linked to occupation profiles and occupancy rate, in the real operation the results on energy and consequently economical saving might vary from the model's results. In addition the possible maintenance of the system was not taken into account.

11.1 System cost

For a customer the final cost of an installed system is composed by two main categories of cost: the cost linked to the purchase of manufacturing products and the cost related to the workers for building the system.

The former comprehends the AHU, ducts and equipment such as motor controlled dampers, diffusers, plenums for the pressure balance before the diffusers, different kind of sensors and communication system. The latter includes the build of the duct's net, from now ducting, and installation of the equipment and the connections, from now installation.

Based on company experiences, a plausible partition of the overall costs for the analysed sub-system is reported in Table 27.

Table 27 - System cost [€]

	CAV	VAV	DCV & DCV Class I
AHU	16 000	18 000	12 000
Equipment	9 000	9 000	19 500
Ducts	11 000	11 000	9 000
Ducting	4 500	4 500	4 000
Installation	9 000	9 000	11 000
Total	49 500	51 500	55 500

In a first analysis it is visible that the difference between CAV and VAV system is the price for the AHU that, in the VAV system is more expensive because of the presence of the bypass module, Figure 6.

Differently between CAV / VAV and DCV system is the cost for AHU, ducts and ducting decreases but increases the equipment and installation cost.

The reduction for the AHU cost is achievable because of the possibility to move the air where needed, one of the pros of a DCV system. That entails the decreasing of the air volume handled by the AHU and consequently the decreasing of the AHU itself at least of one size. For example, if the CAV system needs an AHU that handle 2 500 l/s, the equivalent DCV system for the same building needs a 2 000 l/s AHU.

Because there is less air in the ducts, also the size of ducts at the central level can be reduced, lowering down the price of the ducts and consequently decreasing the ducting cost.

In the opposite direction, the costs for equipment increase because, for moving the air where it is needed and reducing the air volume consistently with the demand, more zone/room dampers are needed, all connected with room's sensors and electronic management system. Because of that the installation cost also rises.

As visible from Table 27 the additional cost of a DCV system compared to a CAV system is approximately 12% and only 8% more compared to a VAV system.

11.2 Operating cost

In the choice of one system instead of another it is important to also evaluate the operational cost (OC), defined as the annual cost incurred on a continuous process (businessdictionary, 2014).

As seen in chapter 9, the contribution of ventilation, heating and cooling have a different weight in the different scenarios. In addition, ventilation is always achieved from electric sources, otherwise thermal energy for heating and cooling can be produced with several methods characterised by their own efficiency and primary source, thermal instead of electric.

Because of that two different circumstances were taken into account: the installed production system and a hypothetical scenario where the thermal energy is split in heating, directly purchased from district heating net, and cooling produced in place with an high efficiency air-water chiller, from now scenario (DH-CH).

Figure 56 displays how important the production system is. It represents the equivalence of the energy demanded by the building in terms of thermal energy for heating and cooling and electric energy for ventilation with the purchased energy utilized in the production system for obtaining it in two different scenarios. Because of it represent an example, the only CAV system is represented.

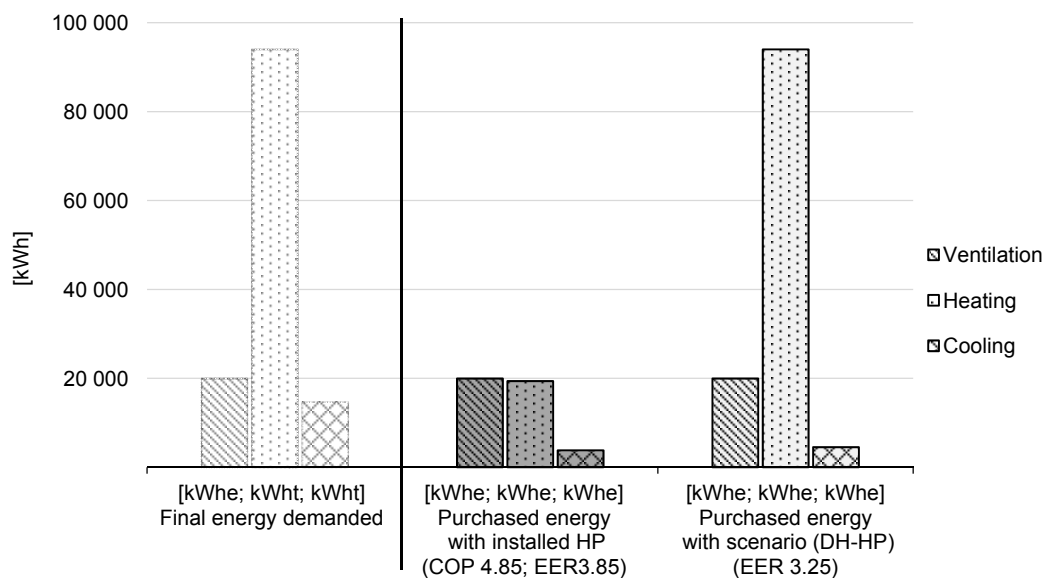

Figure 56 - Differences in the energy production

In Figure 56, the columns at the left of the vertical line represent the energy demanded by the building for the specific target respectively ventilation heating and cooling. Differently the right side represents how much energy has to be purchased to reach the goal in case of two different energy production systems.

In both production systems it can be seen that the electric energy for the ventilation does not change because it is purchased from the electric net and utilised without conversions. Otherwise, for heating and cooling targets, there is the necessity to pass through a conversion system. In the first case an HP convert the purchased electric energy in thermal, differently in the second case the thermal energy is used without halfway conversion because it arrives directly from district heating and the cooling, purchased the electric energy, it has to be converted in thermal energy through a chiller.

Referring to Figure 56, we can see that the purchased energy for the heating purpose is 79% smaller if a HP is installed instead of a connection with the district heating. Because of that it is clear that, even if the primary sources have the same cost, how much the choice of the production system can affect the operating cost.

In chapter 0 for each system scenario such as CAV, VAV, DCV and DCV class I the annual energy consumption in electric kilowatt-hours as overall value and split in its different composition was evaluated.

Table 28 reports a recap of the simulated consumption in the standard year.

Table 28 - Modelled energy consumption for each scenario

System scenario	Modelled consumption [kWh _e /a]			
	Overall	Ventilation	Heating	Cooling
CAV	43 158	19 961	19 381	3 816
VAV	34 132	13 738	13 566	6 828
DCV	19 839	6 086	10 634	3 119
DCV Class I	17 552	6 097	9 044	2 382

11.2.1 Energy price

The electric energy price was taken from (epp.eurostat.ec.europa.eu, 2014) as the average value in Sweden for 2013. For the district heating price was taken as reference for the price

in the Falkenberg district (falkenberg-energi, 2014). The sources' prices are reported in Table 29. As exchanging rate was taken the ratio €/SEK = 8,874 (Google, 2014) updated to 2014/03/20.

Table 29 – Energy price for electricity and district heating

Electricity		District heating					
[€/kWh _e]	[SEK/kWh _e]	Price category	Annual consumption	Fix costs		Variable costs	
			[MWh _t /a]	[€/a]	[SEK/a]	[€/kWh _t]	[SEK/kWh _t]
0,135	1,2	(1)	80	2 569	22 794	0,08	0,70
		(2)	193	5 586	49 570	0,08	0,70

All the following results are expressed in Euro.

11.2.2 Operating cost with installed HP

Considering the installed energy production system such as a ground coupled double effect heat pump with a COP of 4,85 and a EER of 3,85 the electric energy is the only energy source coming into the building.

Because of that, taking into account the modelled annual energy consumption in Table 28 and the electric energy price in Table 29, the expected operating cost for the actual situation displayed in Table 30 was evaluated with equation (28).

$$OC = E_{el} \cdot p_{el} \quad (28)$$

Where:

OC	operating cost	[€/a]
E _{el}	expected modelled annual consumption	[kWh _e /a]
p _{el}	electric energy price	[€/kWh _e]

Table 30 – installed HP: operating cost [€/a]

System scenario	Operating cost [€/a]			
	Overall	Ventilation	Heating	Cooling
CAV	5 826	2 695	2 616	515
VAV	4 620	1 855	1 831	934
DCV	2 678	822	1 436	421
DCV Class I	2 366	823	1 221	322

For the operating cost in Swedish currency see Table 64 in Appendix A.4.

11.2.3 Operating cost in scenario (DH-CH)

Because of the differences in the energy production, the cost of purchased energy affect significantly the operating cost for an HVAC system, an hypothetical production scenario, based on the most common Swedish conditions was considered.

Therefore, it was considered the following: the heating energy as purchased from the district heating net and the cooling energy produced in loco with a high efficiency class air-water chiller of approximately 30 kW with EER of 3,25.

Because of that, for the evaluation of the total operating cost ventilation, heating and cooling contributions must be evaluated separately with equations (29), (30), (31) and (32).

$$OC = OC_v + OC_h + OC_c \quad (29)$$

$$OC_v = E_{el,v} \cdot p_{el} \quad (30)$$

$$OC_h = E_{el,h} \cdot COP_{HP} \cdot p_{DH,v} + p_{DH,f} \quad (31)$$

$$OC_c = E_{el,c} \cdot \frac{EER_{HP}}{EER_{CH}} \quad (32)$$

Where:

OC_v	partial operating cost for ventilation	[€/a]
OC_h	partial operating cost for heating	[€/a]
OC_c	partial operating cost for cooling	[€/a]
$E_{el,v}$	partial expected consumption for ventilation	[kWh _e /a]
$E_{el,h}$	partial expected consumption for heating	[kWh _e /a]
$E_{el,c}$	partial expected consumption for cooling	[kWh _e /a]
$p_{DH,v}$	variable price for district heating	[€/kWh _t]
$p_{DH,f}$	fix price for district heating	[€/a]
COP_{HP}	COP for the installed heat pump	
EER_{HP}	EER for the installed heat pump	
EER_{CH}	EER for the high efficiency air-water chiller.	

The expected energy consumption for the heating purpose (Table 31) can be evaluated multiplying values from Table 28 times the COP for the heat pump. With these values, based on price ranges in Table 29, can be stated that CAV system own to the price category 2 when VAV, DCV and DCV class I are included in the category 1.

Table 31 - Expected heating energy in thermal kilowatt-hours

System scenario	Heating energy [kWh _t]
CAV	93 998
VAV	65 795
DCV	51 575
DCV class I	43 863

Because of this, the CAV system falls into the price category 1 otherwise the other systems would be in the price category 2 reported in Table 29.

Table 32 sums up the operating cost for the scenario (DH-CH).

Table 32 - Scenario (DH-CH): operating cost [€/a]

System scenario	Operating cost [€/a]			
	Overall	Ventilation	Heating	Cooling
CAV	16 327	2 695	13 022	610
VAV	10 734	1 855	7 774	1 106
DCV	7 969	822	6 648	499
DCV Class I	7 243	823	6 039	381

For the operating cost in Swedish currency see Table 65 in Appendix A.4.

11.2.4 Operating cost, comparison between installed HP and scenario (DH-CH)

Figure 57 shows in a sequential analysis the differences between the energy production method in the operating cost and in its components for ventilation, heating and cooling.

It can be seen that the baseline constituted by the ventilation costs is the same for both the installed scenarios because it is not influenced by it.

On the contrary, for the heating and cooling costs big differences can be seen especially for the heating expenses. Moreover, if in both the scenarios the cooling operating costs rise and drops by exactly the same percentage (+81%, -55%, 23,6%) following the upgrade from CAV to DCV class I, the percentage of reduction in the heating expenses are not coupled because of the construction of the price of the thermal energy supplied by the district heating.

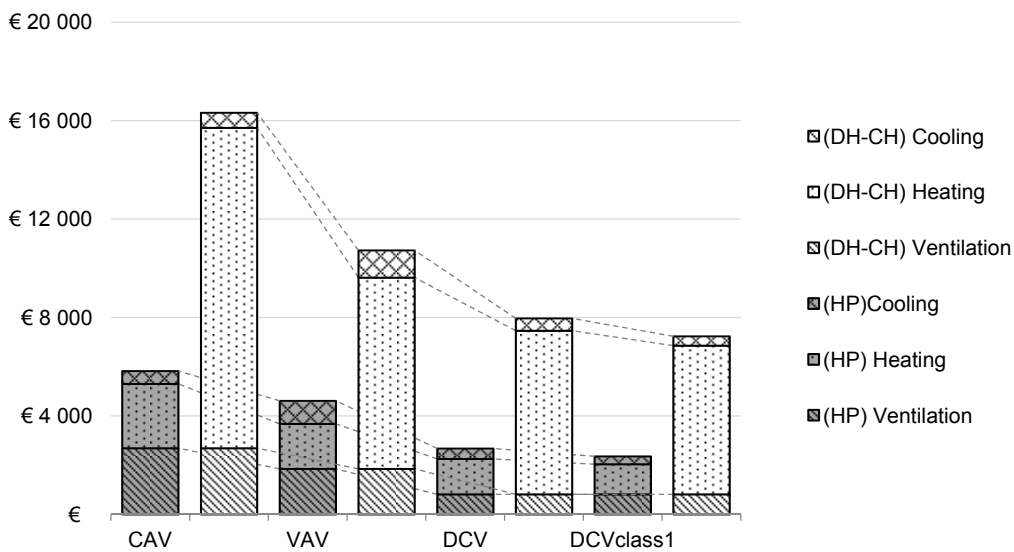

Figure 57 - Comparison between the production scenarios (HP; DH-CH) in the different system scenarios CAV, VAV, DCV, DCV Class I

Table 33 displays the percentage of heating operating cost reduction.

Table 33 - Percentage of reduction in heating operating cost

	CAV→VAV	VAV→DCV	DCV→DCV Class I
Installed HP	30%	21,6%	15%
Scenario (DH-CH)	40,3%	14,5%	9%

From Figure 57 and Table 33 it is interesting to see how much the internal set points in the same installation affect the heating operating cost (DCV → DCV class I). Usually to keep a higher comfort level inside the building there is the necessity to use more energy and therefore larger costs. In this specific case, because of the analysis of chapter 7.3.2 there is an energy reduction with decrease of operating costs. Because of that in the process of optimisation from CAV to DCV class I there is an additional final overall operating cost reduction from DCV to DCV class I of 12% in installed HP case and of 9% in scenario (DH-CH).

This additional reduction in the operating cost, achieved only by setting the correct internal temperature set points, highlights the clear importance that the right indoor temperature set points have on operating cost in systems.

11.3 Payback period

As usual, even in that analysed case the systems with lower operating costs also have a higher purchase price. The cost of different system scenarios are reported as purchase cost in Table 27 and operating cost in Table 30 and Table 32.

For a customer who has to choose between two different systems where one is characterized by a higher capital investment at front of a small operating cost and the other characterised precisely by the opposite conditions, it is really important to know the payback period (PB).

Payback period (PB) is defined as the length of time required to recover the cost of an investment and is calculated by the cost of investment divided by the annual cash inflow. The payback period is an important parameter to understand the influence on an investment as shorter payback periods are typically preferred (investopedia, 2014).

In that analysis the cost difference between the system scenarios was considered as the cost of investment and the saving achievable with the system improvement scenario was taken as annual cash inflow. Because of that, the payback period was evaluated for every system improvement scenario such as CAV to DCV, VAV to DCV, CAV to DCV class I and VAV to DCV Class I with equation (33).

$$PB = \frac{AC_i}{s_i} \quad (33)$$

Where:

PB	payback period	[y]
AC _i	additional cost in the system improvement scenario <i>i</i>	[€]
s _i	saving achieved with the system improvement scenario <i>i</i>	[€]

Referring to Table 27 can be evaluated the additional cost in the system improvement scenario displayed in Table 34.

Table 34 - Additional cost in the system improvement scenario

System improvement scenario	Additional cost [€]
CAV-DCV	6 000
VAV-DCV	4 000

Values in Table 34 correspond to an additional investment of 12% in the system improvement scenario CAV-DCV and 8% in the VAV-DCV scenario.

Employing the comparative analysis it is possible to evaluate the payback period, in years or months, in the two energy production scenarios taken into account until now.

Note that in the evaluation of the payback period the maintenance was not taken into account.

11.3.1 Payback period with installed HP

In this paragraph the payback time for the all system improvement scenarios was evaluated. For this evaluation the only HP production system was considered.

With reference to Table 30 representing the operating cost for the different system scenarios in this production situation come up Table 35 that contains the annual economic saving achieved in the various system improvement scenarios.

**Table 35 - Real production installed HP:
overall annual economic saving in different system improvement scenario**

	CAV-DCV	VAV-DCV	CAV-DCV Class I	VAV-DCV Class I
Economic saving [€]	3 100	1 900	3 500	2 300

Applying equation (33) it is possible to evaluate the payback period in years. Figure 58 displays the payback time in years for choosing a DCV system instead of a CAV or a VAV in both the conditions of keeping the same indoor comfort or even improving it. Figure 58 also displays the trend of the economical saving across the years not taking into account the maintenance cost.

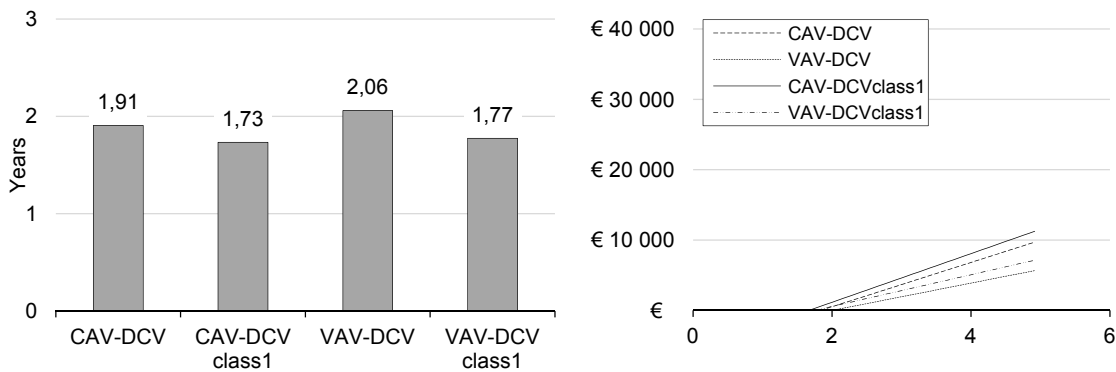

Figure 58 - Real energy production installed HP: payback period and trend for economical saving

Figure 58 shows a payback period that, in three cases out of four, is shorter than two years. In addition looking at the trend for the saving, a foresight of economical saving can be done in a panorama of three, five and ten years from the start-up of the installed system can be found Table 36.

**Table 36 - Real production installed HP:
predicted economical saving in ten years panorama**

Years after purchase	Predicted economical saving			
	CAV-DCV	VAV-DCV	CAV-DCV class I	VAV-DCV class I
3	3 700	1 900	4 600	2 800
5	10 000	5 800	11 500	7 300
10	25 700	15 500	28 800	18 600

With the foresight in Table 36 it can be seen that the choice of a DCV instead a CAV or VAV system is always convenient. All these evaluations are made without taking into account the maintenance cost that could affect the results.

11.3.2 Payback period in scenario (DH-CH)

In the hypothetic production scenario such as district heating and chiller, the same considerations can be applied as in the previous case.

With reference to Table 32 the operating savings are evaluated in Table 37 and, applying equation (33) the payback period can be evaluated as displayed in Figure 59 which also shows the trend for the saving.

**Table 37 – Production scenario (DH-CH):
overall annual economic saving in different system improvement scenario**

	CAV-DCV	VAV-DCV	CAV-DCV Class I	VAV-DCV Class I
Economic saving [€]	8 400	2 800	9 000	3 500

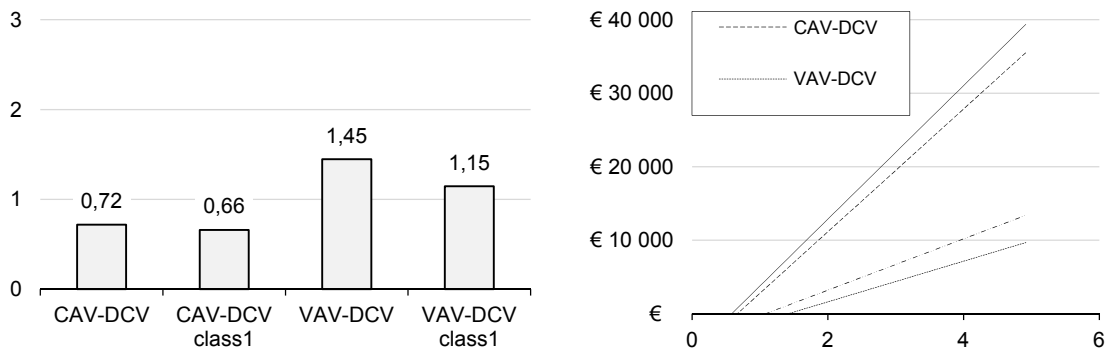

Figure 59 - Production scenario (DH-CH): payback period and trend for economical saving

In this case the evaluation of the payback period shows that the investment is recovered for the improvement from CAV to DCV in less than one year, differently it takes a longer period if a DCV was chosen instead of a VAV system.

Based on the trend for the economic saving of Figure 59 the foresight can be drawn of saving in a three, five and ten years scenario reported in Table 38.

Table 38 - Production scenario (DH-CH): predicted economical saving in ten years panorama

Years after purchase	Predicted economical saving			
	CAV-DCV	VAV-DCV	CAV-DCV Class I	VAV-DCV Class I
3	19 502	4 379	21 954	6 693
5	36 218	9 910	40 123	13 677
10	78 008	23 737	85 545	31 136

All these evaluations are made without taking into account the maintenance cost that could affect the results.

11.3.3 Payback period, comparison between real installed HP and scenario (DH-CH)

Comparing the two production cases using the payback period it can be seen that with a scenario (DH-CH) instead of the installed HP there is evidence in the reduction of the payback period. Reduction that amounts approximately to 60% in the system improvement scenarios from CAV to DCV and from CAV to DCV class I and approximately to 30% in both VAV to DCV and VAV to DCV Class I.

In all the analyses it appears that the profitability of a DCV system is higher in the scenario (DH-CH) compared to the installed HP case. This consideration leads to think that the DCV system is more suitable if the production system is not at the top of the efficiency class.

In both considered production scenarios (HP and DH-CH), the economical convenience is more remarkable in case of a system improvement scenario CAV-DCV instead of a system improvement scenario VAV-DCV.

12 Discussion and conclusion

The overall master thesis work can be split into two large parts linked with each other. The first large part is centred on the monitoring system and focuses on the indoor environmental quality based on the temperature and relative humidity records. In addition, the long period comfort (De Carli, M, 2006) was evaluated and, according to European Standard (EN 15251, 2007), the energy and humidity classifications were assessed. From this part also the internal temperature set points were obtained and used as internal set points for the models constructed in the second part of the master thesis.

The second part relates to the modelling and simulation of different ventilation systems such as CAV, VAV, DCV and DCV class 1 in order to show the advantages achievable using a DCV system instead of another systems. These evaluations were developed focusing on the energy consumption and on the economic expenses whilst keeping or even improving indoor climate conditions. In addition, for the economic assessment two production systems were considered in order to focus the attention on the purchased energy expense that has to be purchased to reach and keep the indoor temperature set points result from first part of the master thesis work.

Monitoring and indoor environment

Because of several adjustments in the operations and usage of areas, in the course of time the equipment in the analysed facility received many changes. Fan coils were added to retail and packing zones, in the latter an additional split unit was also installed and, because of the usage changed from stock to working place, 300 l/s were added to the designed airflow rate. All these changes were not communicated to the monitoring staff. In addition, the additional fan coils were not monitored.

The monitoring was planned to evaluate the functioning and energy consumption of the installed system and to assess the indoor environmental quality using parameters of temperature and relative humidity. From the analysis of recorded data the main finding is the fundamental importance that a continuous monitoring has in the correct operation of a ventilation system, which has to provide the best indoor comfort using as little energy as possible.

A continuous monitoring, possibly in communication with maintenance service or building management, would have quickly highlighted regulation problems or malfunctioning during the operation. In this instance related to the specific fan power (SFP) or to the pressure unbalance in this building. The former would have reduced the energy consumption during the unoccupied periods; the latter would have surely avoided air leakages through the building envelope to the interior (after the increase of the airflow) and consequently avoiding larger energy consumption during the operation.

Furthermore, the same continuous monitoring would have also drawn attention to the considerations done in the energy classification based on European Standard requirements (EN 15251, 2007). In this evaluation it was revealed that the monitored zones would be classified as class I if they would have a better regulation. In fact, the class II or higher is reached even if the zones are slightly overheated or overcooled. The continuous monitoring with feedback would allow a lower energy consumption in winter and summer operation and a higher building classification.

Others considerations can be done for the indoor comfort analysis. As explained in this work, in the packing zone were notified complaints from the staff due to cold discomfort during wintertime. The indoor temperature analysis does not support these complaints of discomfort. Yet, in the packing zone there is only one monitoring spot placed in the centre of the zone, the thermal discomfort could have occurred far from this point. For example, the thermal discomfort could have occurred close to the warehouse that has a temperature lower than the packing area.

A continuous monitoring could also immediately confirm or deny thermal dissatisfactions giving a quick input on the need of adjustment in the system. It could also give information on the particular location for the discomfort, giving additional information to improve the wellness also in other zones.

This find is reinforced based on the long period comfort analysis (De Carli, M, 2006) and evaluation based on (ISO 7730, 1994), which does not show a cool discomfort in the packing zone during winter time. On the contrary, this investigation shows that the only warm discomfort would be expected in the packing and retail zones during summer time and cool discomfort in the office zone during the all analysed year. Excluding the usage of the different zones the main difference between office, packing and retail zones is that the former is characterised by a high temperature personalisation because of the installation of active beams. The high personalisation and the important cool discomfort studied in this zone lead one to think that a lower temperature is desired inside the building.

This consideration, taking also into account the geographical location of the building, is coherent with the adaptive thermal comfort theories that states that a person adapts its body to the weather of the hosting place. The direct consequence of this observation is that to evaluate the indoor comfort conditions the geographical context plays a fundamental role.

As recalled earlier, the HVAC system changed a lot during the years and various components were added such as split unit and fan coils. All these components were neither monitored, nor were their installation communicated to the monitoring staff. In a prospective of a continuous monitoring of a facility all the system improvements such as facility installation or change of usage in zones as occurred in the packing zone, would have to be communicated and recorded.

In addition the monitoring system should be improved with parameters on the energy production system and if needed across the junctions between the production and the sub-systems level in order to display detailed data on the total energy consumed in the building and, if present, from each sub-system. This improvement of the monitoring system would provide detailed knowledge on the overall energy consumption, also information on possible inefficiencies inside each sub-system on the distribution and diffusion system.

Modelling and simulation

The difficulties and the questions found during the model constructions were mostly related to the incoherence in the temperature profiles in the packing zone, the definition of the indoor temperature set points and the functioning time for the different components. All these points prove the importance of a continuous monitoring and the need to be informed on the usage changes occurred in the zones as described earlier. In addition, the questions come up in the definition of the building shape show also the necessity of a detailed documentation about the structure, on its design and on its further adjustments.

This study shows the importance of employing advanced simulation software in the comparison of different HVAC systems in a building that otherwise would not be possible to compare with each other. The comparison of the CAV, VAV and DCV systems show that in the best case (from CAV to DCV) the energy consumption to reach and keep the indoor temperature set points decrease below 50%. It is important to state that this reduction is achieved simulating an occupancy rate equalling to 50%. An occupancy of 50% is a wide conservative value because the occupancy rate would be around 28-30% in a typical office and it would not reach the occupancy of 25% inside the a typical retail. That means that the energy saving achievable with a DCV system could be even larger than the modelled one in this work.

It is interesting to know how the energy saving is split in a DCV system such as heating, cooling and ventilation. An overall picture of this split shows that the highest energy reduction is achieved in the fans than in the heating and the lowest energy reduction is found in the cooling energy. Even in that evaluation, as well as for the indoor comfort conditions, the geographical location of the studied building seems to be very important. It is reasonable to think that probably the same

building placed in a different place could have a subdivision of the energy savings even far different from the modelled one. For example, placing the same system (building and ventilation system) in Lisbon, the energy reduction for the cooling could be lower or there could be an increase in the energy consumption due to the increased cost of the dehumidification components, which is not needed in Scandinavian countries. Because of that, the system could appear less favourable than the one studied in this work.

The energy evaluation, or rather how much energy is employed to reach the indoor temperature set points, cannot be separated from an economic assessment that has to evaluate the expense for the purchased energy to reach the purpose. In other words, the aim is to evaluate the operating costs

and, because of the knowledge of the systems' purchase cost calculate the payback period for choosing a DCV system instead of a CAV or VAV.

Because the evaluation is made taking into account the purchased energy and because of the energy division earlier described, in the study were considered two different production systems. The first system is represented by the real installed ground coupled heat pump (HP), the second, based on a Swedish situation, is composed by district heating and chiller (DH-CH). With the HP the electric energy purchased is converted in thermal for heating passing through the COP and in the cooling energy through the EER of the heat pump. Because of lack of knowledge on the heat pump, COP and EER were considered constant during the overall analysis. In the DH-CH case the heating energy was considered to be used directly as purchased from the district heating distribution net, the cooling energy was considered supplied from the chiller passing through its EER, also here considered as constant. As is easy to realise, the HP system is more efficient than the DH-CH.

In view of what came up from this study it can be stated that the payback period is shorter if the installed production system is inefficient. Furthermore, with both the production scenarios the payback periods are rather short, in most of the system improvement scenarios less than two years. Because of that, considering that the additional investment is a small value compared to the overall cost, about 10%, and the short payback period, it can be stated that the choice of a DCV system instead of a CAV or VAV ventilation system is always profitable.

Even in the economic assessment it is right to say that the presented conclusion are relative to this specific kind of building placed in that particular geographical region and, because of that the displayed values cannot be used as generalised values. Taking as example the same building placed in Lisbon, due to the possible higher energy for cooling/dehumidification compared to the heating energy, the two production scenarios could be more similar than the presented one in this study.

It is necessary to recall that all the evaluations and considerations done until now were developed for a hypothetical occupation curve relative to an occupancy rate of 50%.

Recognising the energy savings and economical advantage in the use of a DCV system instead of a CAV or VAV ventilation system, the quantification of that benefit has to be evaluated case by case taking into account the parameters that this study shows as fundamentals. These parameters were identified as occupation curve with occupancy rate, geographical location and installed production system.

Future research

During this research many aspects that could be examined in depth came to the light. These aspects could increase the indoor comfort, possibly reduce the operating costs for a HVAC system and improve the knowledge of the DCV technology in order to give guidelines in the HVAC design and choice of HVAC systems.

The possibility of continuous monitoring could lead to a better system regulation with consequent energy efficiency improvement. An international project in this field has already finished

(www.iSERVcmb.info) where the project consists of the continuous monitoring of buildings and installed systems. This research can provide feedback on the energy efficiency of different HVAC systems and components displaying pros and cons of different installations whilst signalling eventual problems (iServcmb, 2014). The aim is to build a relevant database to develop guidelines on design, choice and management of different HVAC systems in different buildings.

In order to supply the right thermal comfort inside the building, the energy survey could support indoor environmental monitoring on temperature and interviews to people frequenting the building. The questionnaire might be done with a non-invasive and voluntary method with for example a button to press when people exit the facility. This method, already tested to acquire information on the service satisfaction in several shopping chains as personally experience, could be implemented with the predicted mean vote (PMV) values described in the European Standard (ISO 7730, 1994).

With this method, because of the knowledge of the indoor temperature set points and temperature records and with the knowledge of the geographical location, guidelines could be drawn to improve the indoor thermal comfort according with the adaptive comfort theories.

This investigation method could also be used for getting the knowledge on the occupation profiles and occupancy rate for various building activities, as seen during the analysis, one of the most important parameters for evaluating of the advantages of DCV system.

Besides, in order to evaluate and quantify the preference of DCV system instead of a CAV or VAV ventilation system other case studies could be built for facilities placed in different geographical regions. That investigation, because of the strong dependence on the production system, linked with the continuous monitoring described earlier could give important considerations on the quantifying of the preference in the adoption of a DCV system.

These further studies could lead to another evolvement of the HVAC system in order to fit to the human need and activities in a building. That would mean an additional reduction in the energy for the ventilation and conditioning whilst keeping or even increasing the indoor comfort inside the buildings, in other words a step towards a more comfortable and greener world.

13 Appendix A

13.1 Appendix A.1: Measurements and probes

Room level. Indoor environmental data (IED)

Table 39 - Positions and records for IED

ROOM	POSITION	HIGH FLOOR	FROM	RECORDS	TIME STEP
2110	1 st beam	3 m		Temperature and relative humidity for - primary air - secondary air - incoming air (after coil)	6 min
	2 nd beam (supply duct)	-		-Pressure - Valve operation	1min
	desk	1,1 m		Temperature and relative humidity	6 min
Note: errors in records					
2109	beam	3 m		Temperature and relative humidity for - primary air - secondary air - incoming air (after coil)	6 min
2108	beam	3 m		Temperature and relative humidity for - primary air - secondary air - incoming air (after coil)	6 min
111	beam	3 m		Temperature and relative humidity for - primary air - secondary air - incoming air (after coil)	6 min
	Work desk	1,1 m 0,1 m; 1,8 m		Temperature and relative humidity	6 min
101	Behind cash	1.1 m		Temperature and relative humidity	6min
AHU	Unspecified			Temperature for -exhaust air from office zone -supply before main coils -supply after main coils (office duct) -supply after post heat coil (retail duct)	

Note: all the measurement are not simultaneous, but are drifted of 1 min one from the other (e.g 2110 recorded at 6:00, 2019 at 6:01, 2018 at 6:02... ..2110 at 6:06... etc)

Central level. Air handling unit data (AHUD)

Connected by log card

Table 40 - Position and records for AHUD

POSITION	RECORDS	TIME STEP
Supply duct	Airflow-rate	30 min
	Temperature	
	Relative humidity	
Extract duct	Airflow-rate	30 min
	Temperature	
	Relative humidity	
Exhaust duct	Temperature	30 min
	Relative humidity	
Before recovery	Temperature	30 min
	Relative humidity	
Calculated through internal	SFP	30 min
	Efficiency of recovery	

Outdoor weather station

Table 41 - Weather station

LOCATION	RECORDS	TIME STEP
At the exit door to the roof	Temperature	10 min
	Relative humidity	
	Solar radiation on horizontal	
Note: data missing because of problem in sealing		

13.2 Appendix A.2: Building documentation and HVAC sketch

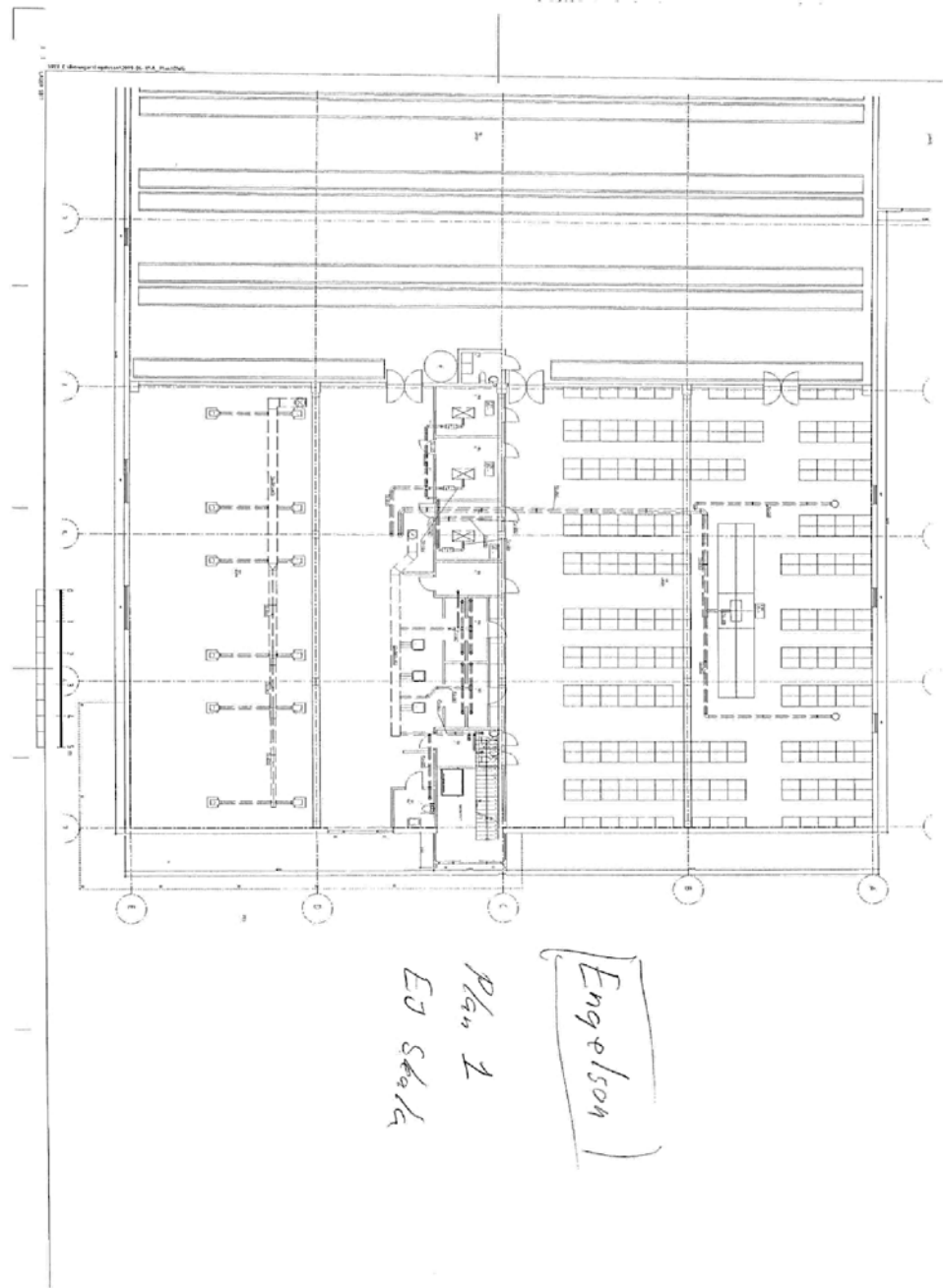

Figure 60 - Ground floor (whole plant and ducts)

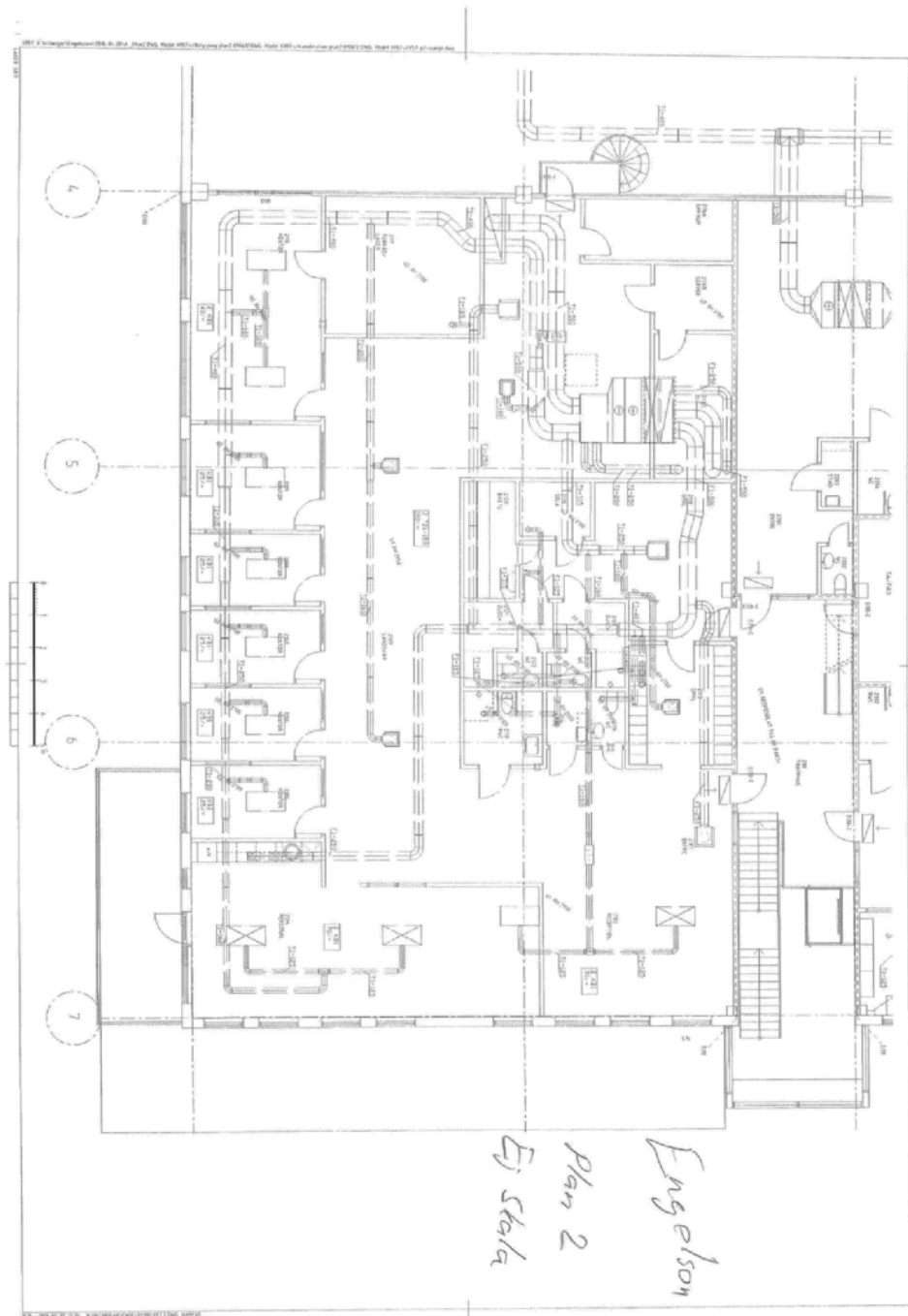

Figure 61 - 1st floor (monitored offices and ducts)

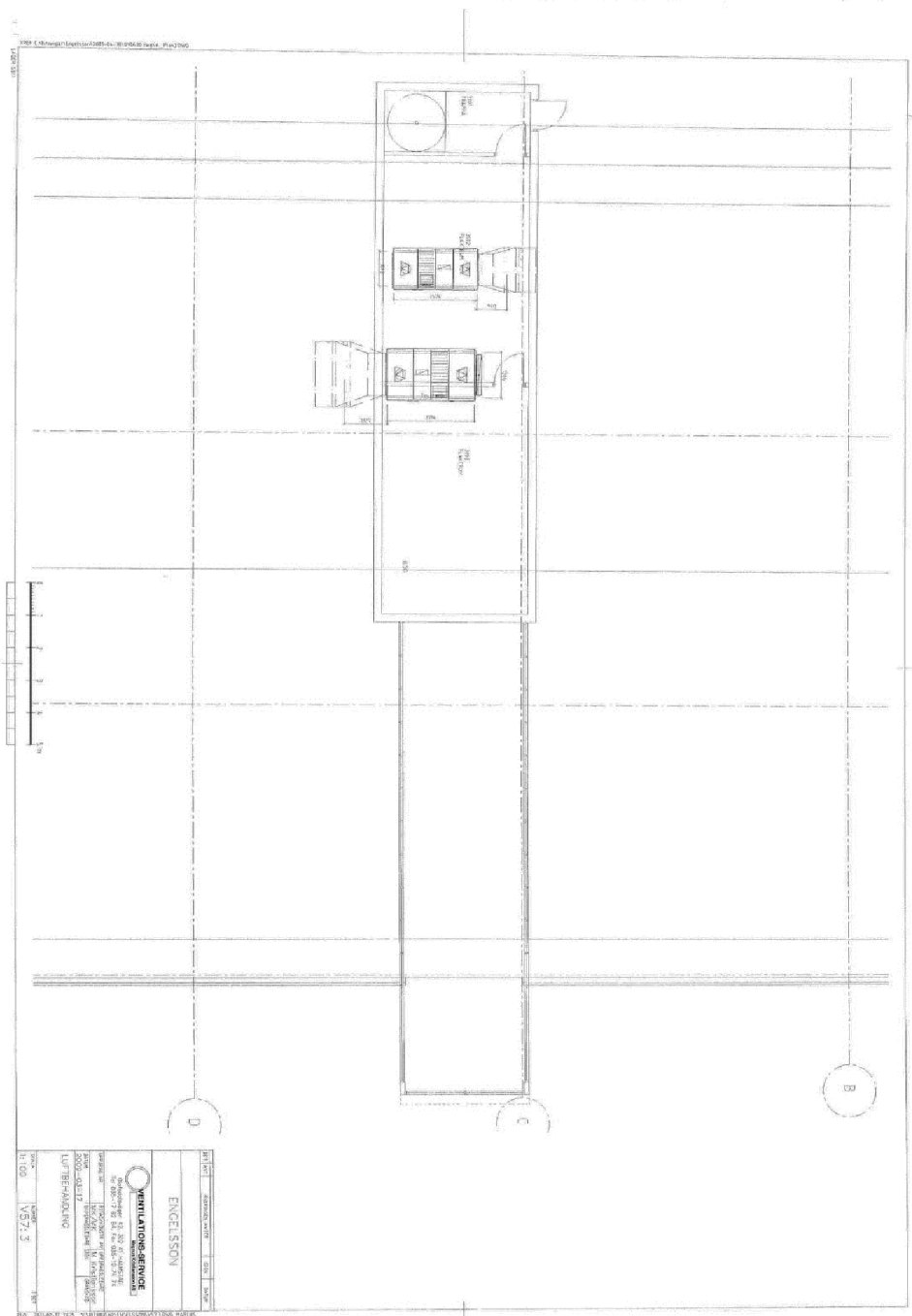

Figure 61 - Roof with AHUs (TA/FA1-TA/FA2)

13.3 Appendix A.3: Reference tables

Activity	Metabolic rates	
	W/m ²	met
Reclining	46	0,8
Seated, relaxed	58	1,0
Sedentary activity (office, dwelling, school, laboratory)	70	1,2
Standing, light activity (shopping, laboratory, light industry)	93	1,6
Standing, medium activity (shop assistant, domestic work, machine work)	116	2,0
Walking on the level:		
2 km/h	110	1,9
3 km/h	140	2,4
4 km/h	165	2,8
5 km/h	200	3,4

Figure 62 - Metabolic rates, Table A.1 Standard ISO 7730

Type of building or space	Category	Temperature range for heating, °C	Temperature range for cooling, °C
		Clothing ~ 1,0 clo	Clothing ~ 0,5 clo
Residential buildings, living spaces (bed room's living rooms etc.) Sedentary activity ~1,2 met	I	21,0 -25,0	23,5 - 25,5
	II	20,0-25,0	23,0 - 26,0
	III	18,0- 25,0	22,0 - 27,0
Residential buildings, other spaces (kitchens, storages etc.) Standing-walking activity ~1,5 met	I	18,0-25,0	
	II	16,0-25,0	
	III	14,0-25,0	
Offices and spaces with similar activity (single offices, open plan offices, conference rooms, auditorium, cafeteria, restaurants, class rooms, Sedentary activity ~1,2 met	I	21,0 – 23,0	23,5 - 25,5
	II	20,0 – 24,0	23,0 - 26,0
	III	19,0 – 25,0	22,0 - 27,0
Kindergarten Standing-walking activity ~1,4 met	I	19,0 – 21,0	22,5 - 24,5
	II	17,5 – 22,5	21,5 – 25,5
	III	16,5 – 23,5	21,0 - 26,0
Department store Standing-walking activity ~1,6 met	I	17,5 – 20,5	22,0 - 24,0
	II	16,0 – 22,0	21,0– 25,0
	III	15,0 – 23,0	20,0 - 26,0

Figure 63 - Recommended indoor temperature for energy calculations, Table A.3 Standard EN 15251

Type of building/space	Category	Design relative humidity for dehumidification, %	Design relative humidity for humidification, %
Spaces where humidity criteria are set by human occupancy. Special spaces (museums, churches etc) may require other limits	I	50	30
	II	60	25
	III	70	20
	IV	> 70	< 20

Figure 64 - Humidity classification, Table B.6 Standard EN 15251

13.4 Appendix A.4: Detailed results

Examples of collected data and the percentage of available data:

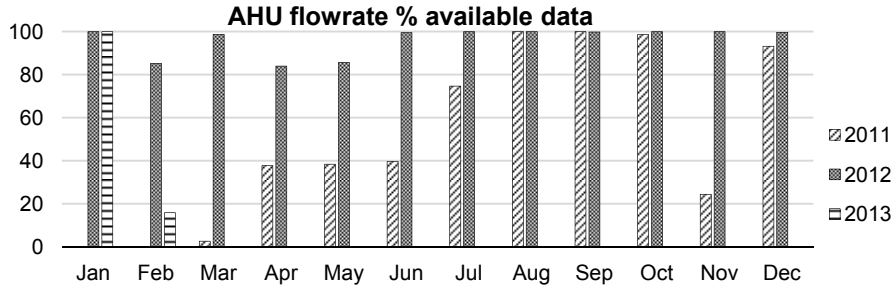

Figure 65 - Airflow: data availability

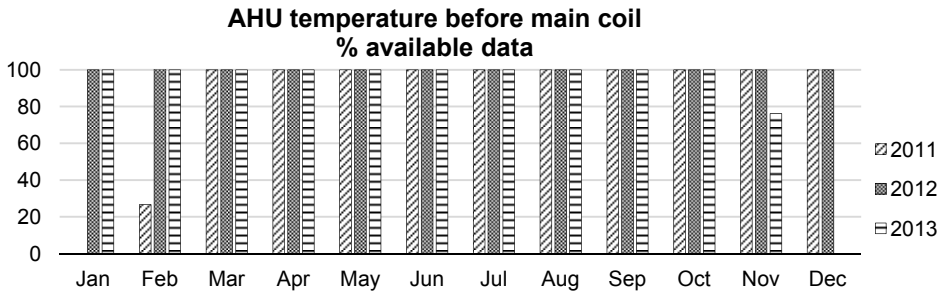

Figure 66 - Temperature before main coil: data availability

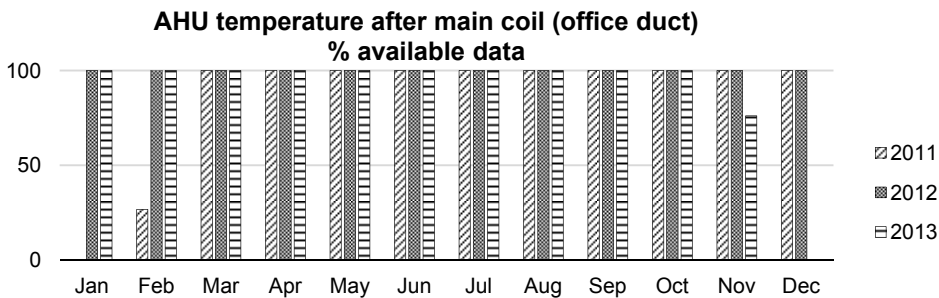

Figure 67 - Temperature after main coil (office duct): data availability

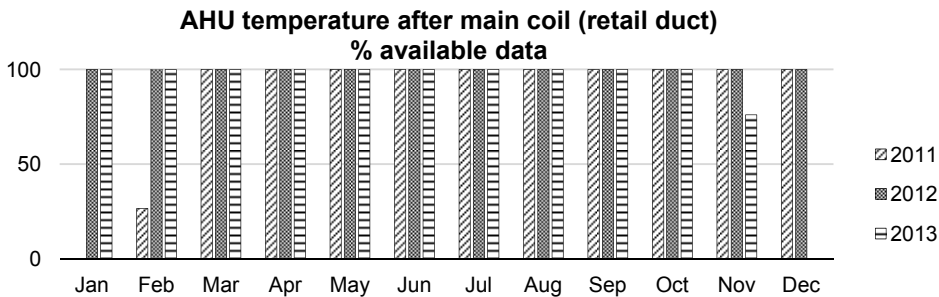
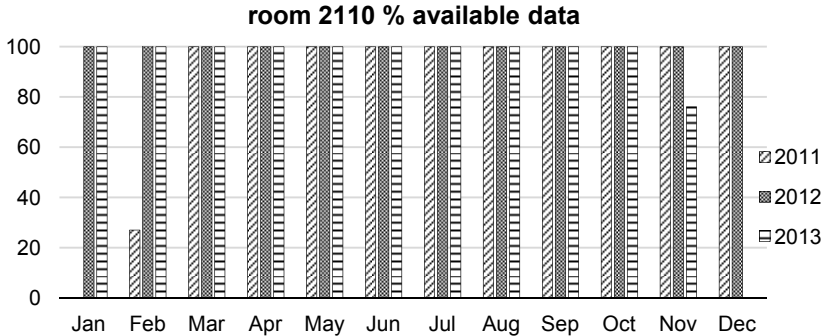

Figure 68 - Temperature after main coil (retail duct): data availability

Room's data



	2011	2012	2013
Jan	0%	100%	100%
Feb	27,1%	100%	100%
Mar	100%	100%	100%
Apr	100%	100%	100%
May	100%	100%	100%
Jun	100%	100%	100%
Jul	100%	100%	100%
Aug	100%	100%	100%
Sep	100%	100%	100%
Oct	100%	100%	100%
Nov	100%	100%	76,1%
Dec	100%	100%	0%

Figure 69 - Room 2110: secondary temperature data availability

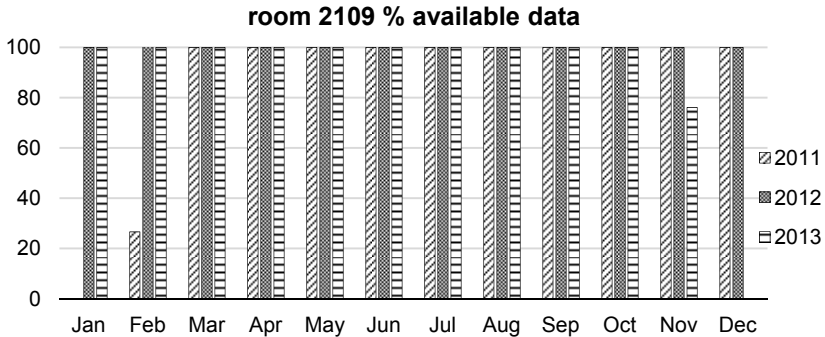

	2011	2012	2013
Jan	0%	100%	100%
Feb	26,6%	100%	100%
Mar	100%	100%	100%
Apr	100%	100%	100%
May	100%	100%	100%
Jun	100%	100%	100%
Jul	100%	100%	100%
Aug	100%	100%	100%
Sep	100%	100%	100%
Oct	100%	100%	100%
Nov	100%	100%	76,1%
Dec	100%	100%	0%

Figure 70 – Room 2109: secondary temperature data availability

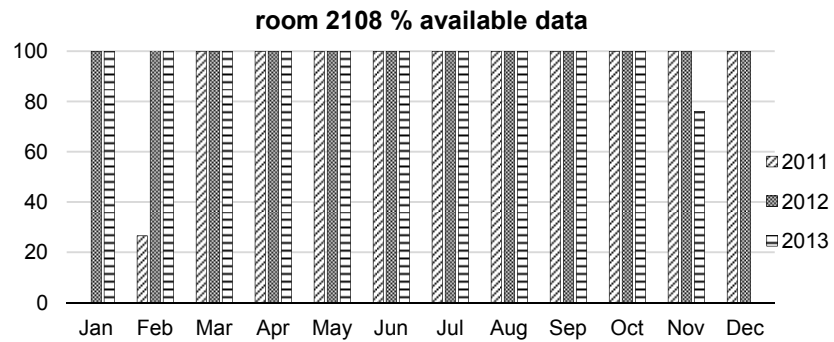

	2011	2012	2013
Jan	0%	100%	100%
Feb	26,6%	100%	100%
Mar	100%	100%	100%
Apr	100%	100%	100%
May	100%	100%	100%
Jun	100%	100%	100%
Jul	100%	100%	100%
Aug	100%	100%	100%
Sep	100%	100%	100%
Oct	100%	100%	100%
Nov	100%	100%	76,1%
Dec	100%	100%	0%

Figure 71 - Room 2108: secondary temperature data availability

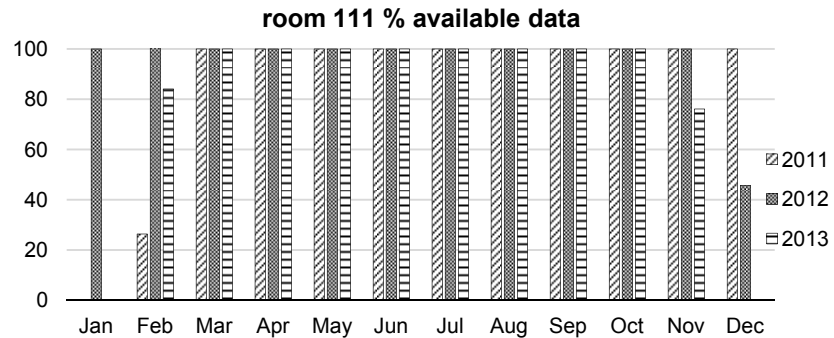

	2011	2012	2013
Jan	0%	100%	0%
Feb	26,3%	100%	84,1%
Mar	100%	100%	100%
Apr	100%	100%	100%
May	100%	100%	100%
Jun	100%	100%	100%
Jul	100%	100%	100%
Aug	100%	100%	100%
Sep	100%	100%	100%
Oct	100%	100%	100%
Nov	100%	100%	76,1%
Dec	100%	45,7%	0%

Figure 72 - Room 111: secondary temperature data availability

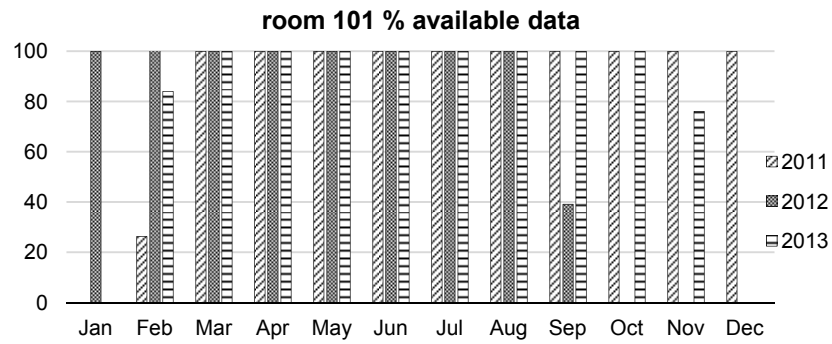

	2011	2012	2013
Jan	0%	100%	0%
Feb	26,3%	100%	84,1%
Mar	100%	100%	100%
Apr	100%	100%	100%
May	100%	100%	100%
Jun	100%	100%	100%
Jul	100%	100%	100%
Aug	100%	100%	100%
Sep	100%	39,2%	100%
Oct	100%	0%	100%
Nov	100%	0%	76,1%
Dec	100%	0%	0%

Figure 73 - Room 101: indoor temperature at 1,1 m

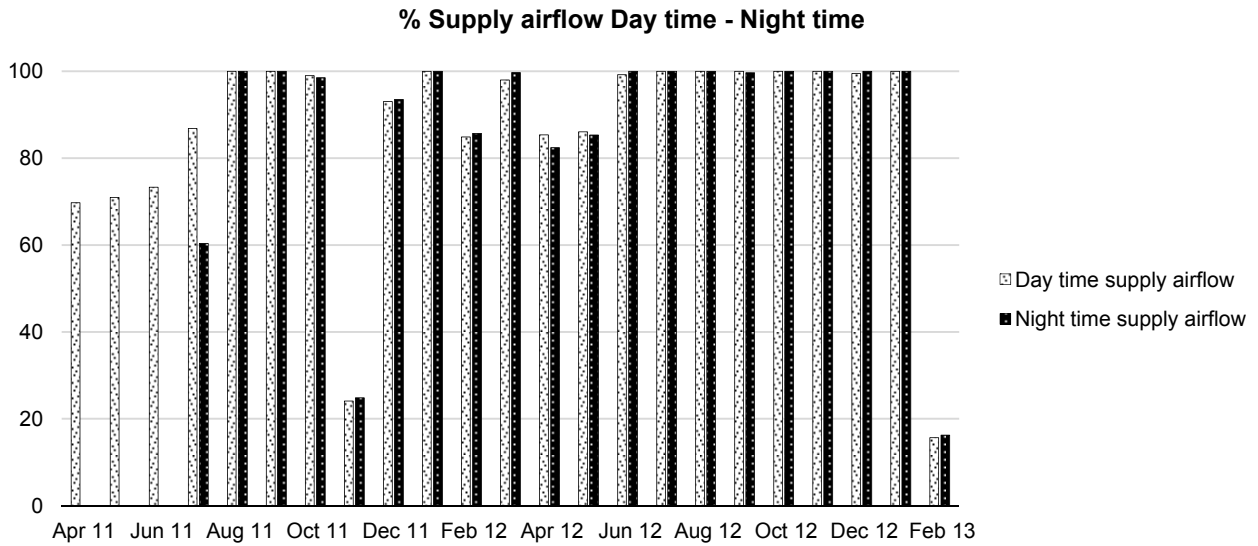

Figure 74 - Supply airflow: day time - night time data availability

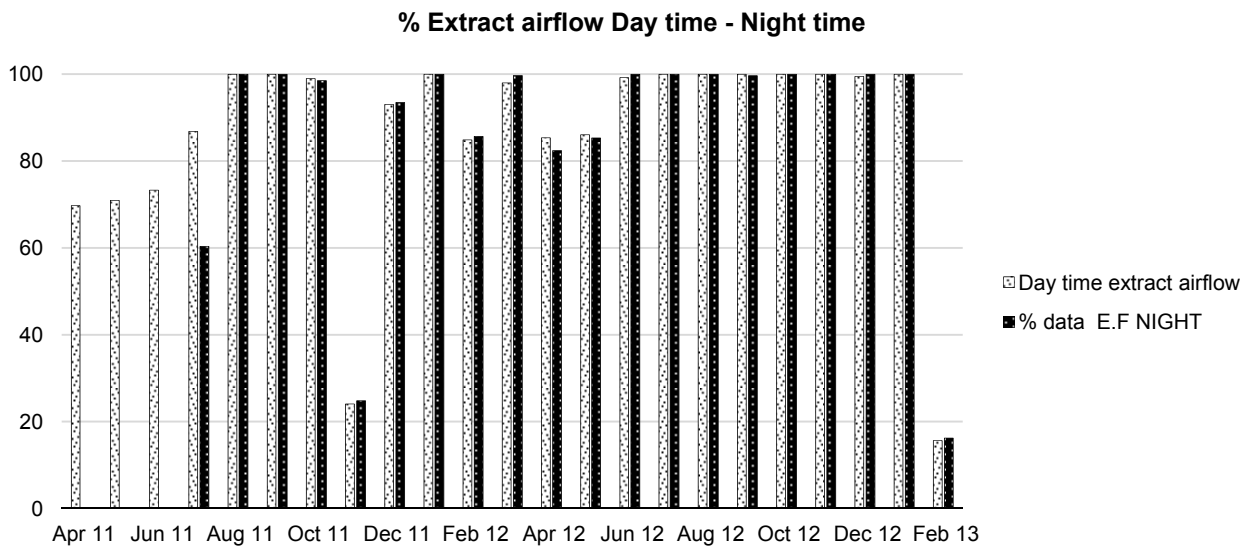

Figure 75 - Supply airflow: day time - night time data availability

Table 42 - Outdoor temperature: data availability

	2011		2012		2013	
	Available data %	Outdoor average temperature [°C]	Available data %	Outdoor average temperature [°C]	Available data %	Outdoor average temperature [°C]
Jan	99,73%	-1,68	100%	-0,28	100%	-2,60
Feb	100%	-2,70	100%	-3,13	100%	-2,28
Mar	100%	1,33	100%	4,11	100%	-2,51
Apr	100%	9,17	100%	4,84	100%	4,74
May	100%	10,68	100%	11,79	99,60%	12,76
Jun	100%	15,17	100%	12,39	100%	14,32
Jul	100%	16,79	100%	15,76	100%	17,12
Aug	100%	15,46	100%	15,51	100%	15,70
Sep	100%	12,71	100%	11,68	100%	10,94
Oct	99,73%	8,17	100%	6,65	99,73%	8,81
Nov	100%	5,58	100%	4,75	0,97%	9,33
Dec	100%	2,81	100%	-3,11	0%	

Table 43 - AHU, monthly percentage of data availability: airflows and temperatures

	2011						2012 (leap year)						2013					
	Airflow		Temperature			Airflow		Temperature			Airflow		Temperature					
	%	value l/s	before coil %	After coil (office) %	After coil (retail) %	%	value l/s	before coil %	After coil (office) %	After coil (retail) %	%	value l/s	before coil %	After coil (office) %	After coil (retail) %			
Jan	-	-	-	-	-	100	1800	100	100	100	100	2200	100	100	100			
Feb	-	-	27	27	27	85,3	1800	100	100	100	15,9	2200	100	100	100			
Mar	2,7	1800	100	100	100	98,8	1800	100	100	100	-	2200	100	100	100			
Apr	37,7	1800	100	100	100	84,0	2200	100	100	100	-	2200	100	100	100			
May	38,4	1800	100	100	100	85,7	2200	100	100	100	-	2200	100	100	100			
Jun	39,7	1800	100	100	100	99,6	2200	100	100	100	-	2200	100	100	100			
Jul	74,7	1800	100	100	100	100	2200	100	100	100	-	2200	100	100	100			
Aug	100	1800	100	100	100	100	2200	100	100	100	-	2200	100	100	100			
Sep	100	1800	100	100	100	99,9	2200	100	100	100	-	2200	100	100	100			
Oct	98,7	1800	100	100	100	100	2200	100	100	100	-	2200	100	100	100			
Nov	24,4	1800	100	100	100	100	2200	100	100	100	-	2200	76	76	76			
Dec	93,2	1800	100	100	100	99,7	2200	100	100	100	-	-	-	-	-			

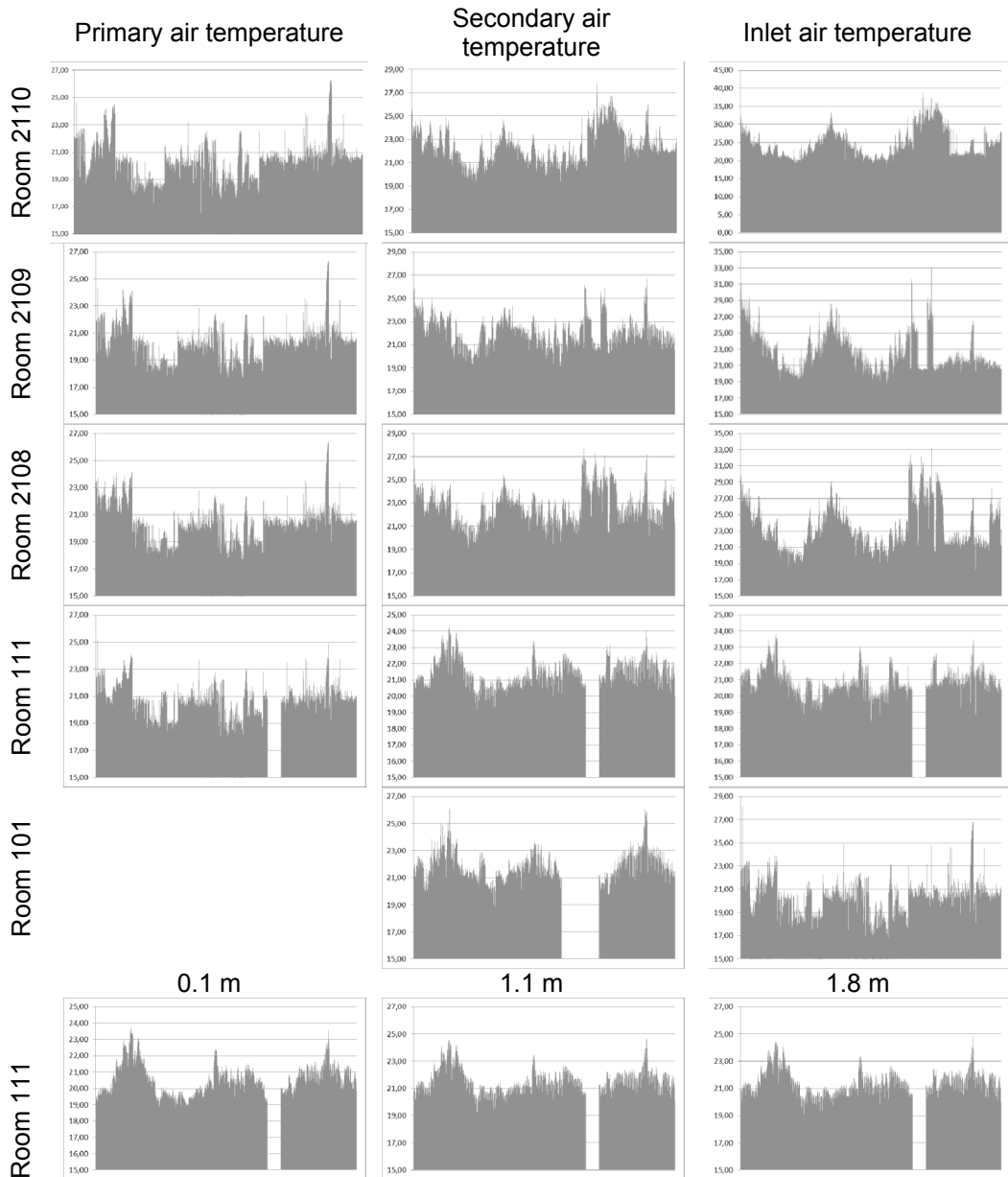

Figure 76 - Indoor air temperature profile

Table 44 - Focus weeks for indoor environmental quality (2011 data)

2011	Data available Feb 22 th – Dec 31 th	
TEMPERATURE	VALUE	WEEK nr.
Daily max	28,6	24
Daily min	-9,3	9
Daily max fluctuation	6,48	16
Weekly max	19,4	32
Weekly min	-3,93	9
Weekly max fluctuation	5,57	8

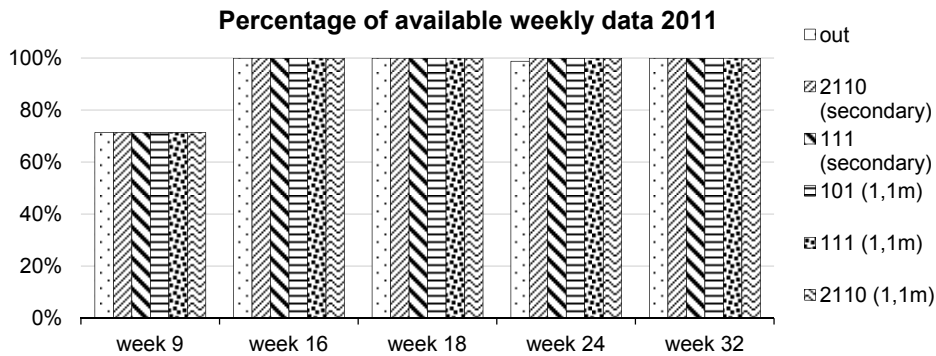

Figure 77 - Percentage of data availability in focus weeks (2011 data)

Table 45 - Focus weeks for indoor environmental quality (2012 data)

2012	Data available Jan 1 st – Dec 31 th	
TEMPERATURE	VALUE	WEEK nr.
Daily max	27,50	21
Daily min	-18,30	49
Daily max fluctuation	6,82	33
Weekly max	18,69	21
Weekly min	-7,92	6
Weekly max fluctuation	5,08	21

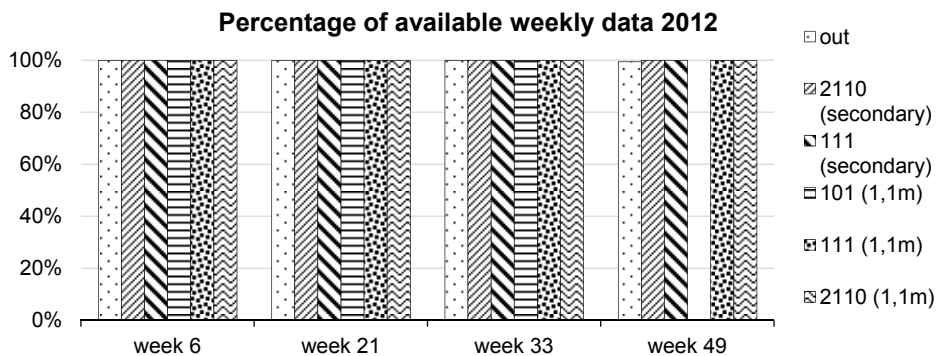

Figure 78 – Percentage of data availability in focus weeks (2012 data)

Table 46 - Focus weeks for indoor environmental quality (2013 data)

2013	Data available Jan 1 st – Aug 03 th	
TEMPERATURE	VALUE	VALUE
Daily max	30,30	31
Daily min	-17,30	4
Daily max fluctuation	6,68	30
Weekly max	19,92	31
Weekly min	-7,14	4
Weekly max fluctuation	6,38	21

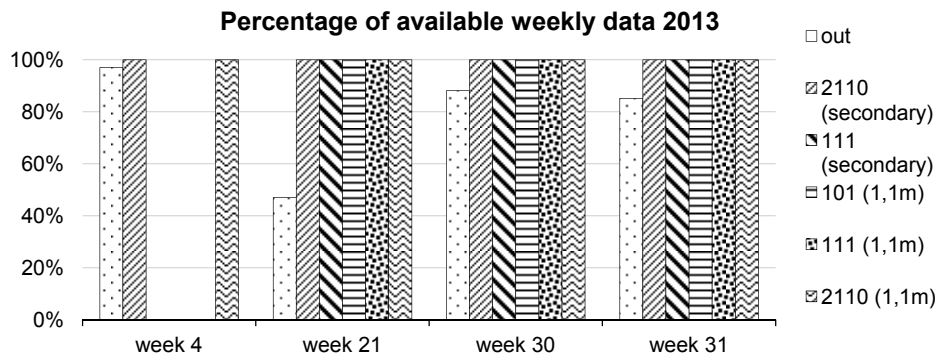

Figure 79 – Percentage of data availability in focus weeks (2013 data)

Year 2012, weekly average minimum temperature (Week6)

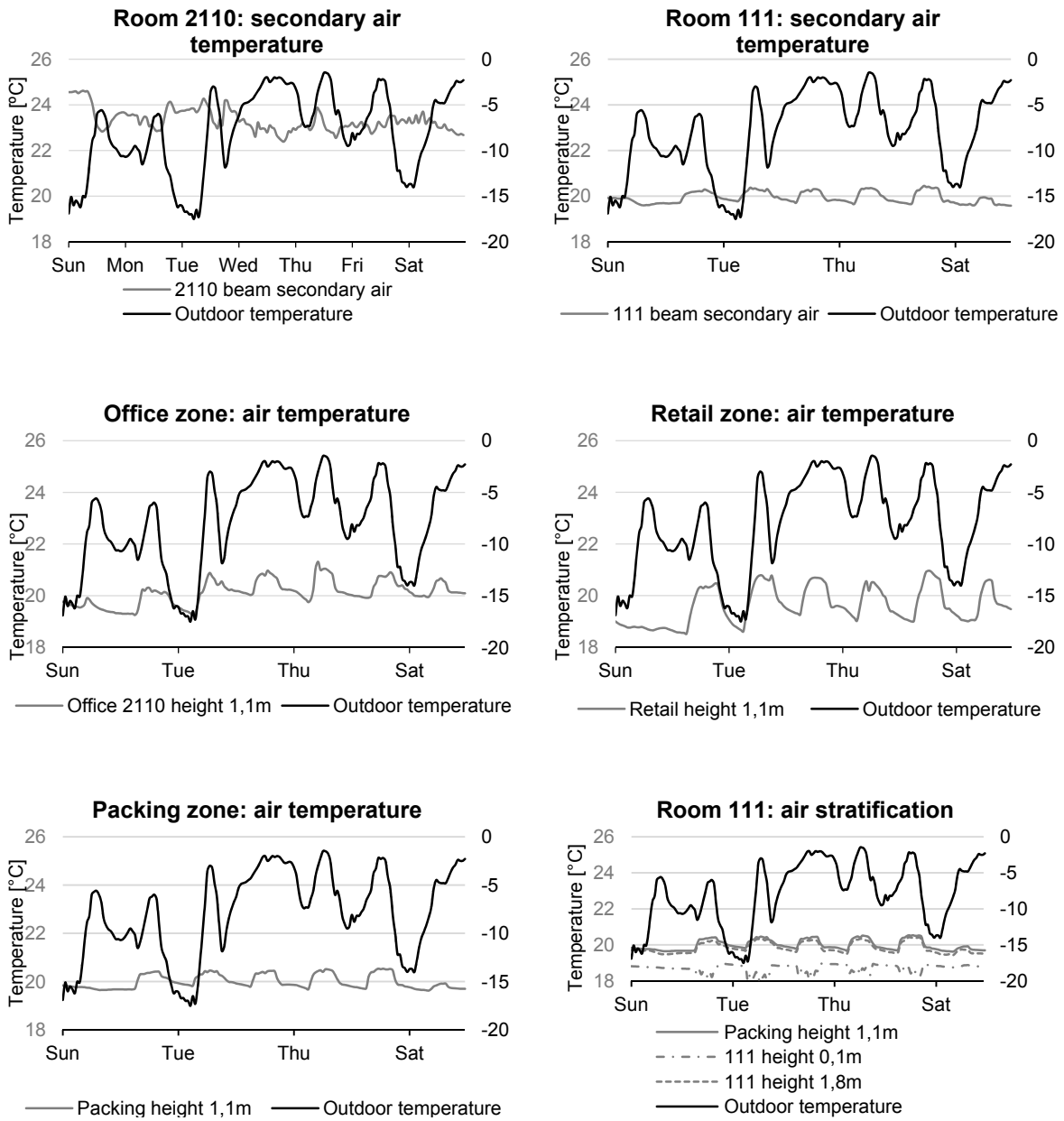

Figure 80 - Temperature profiles for the week with minimum average temperature (year 2012 - week 6)

Year 2012, Daily/weekly average maximum temperature and maximum outdoor fluctuation (Week 21)

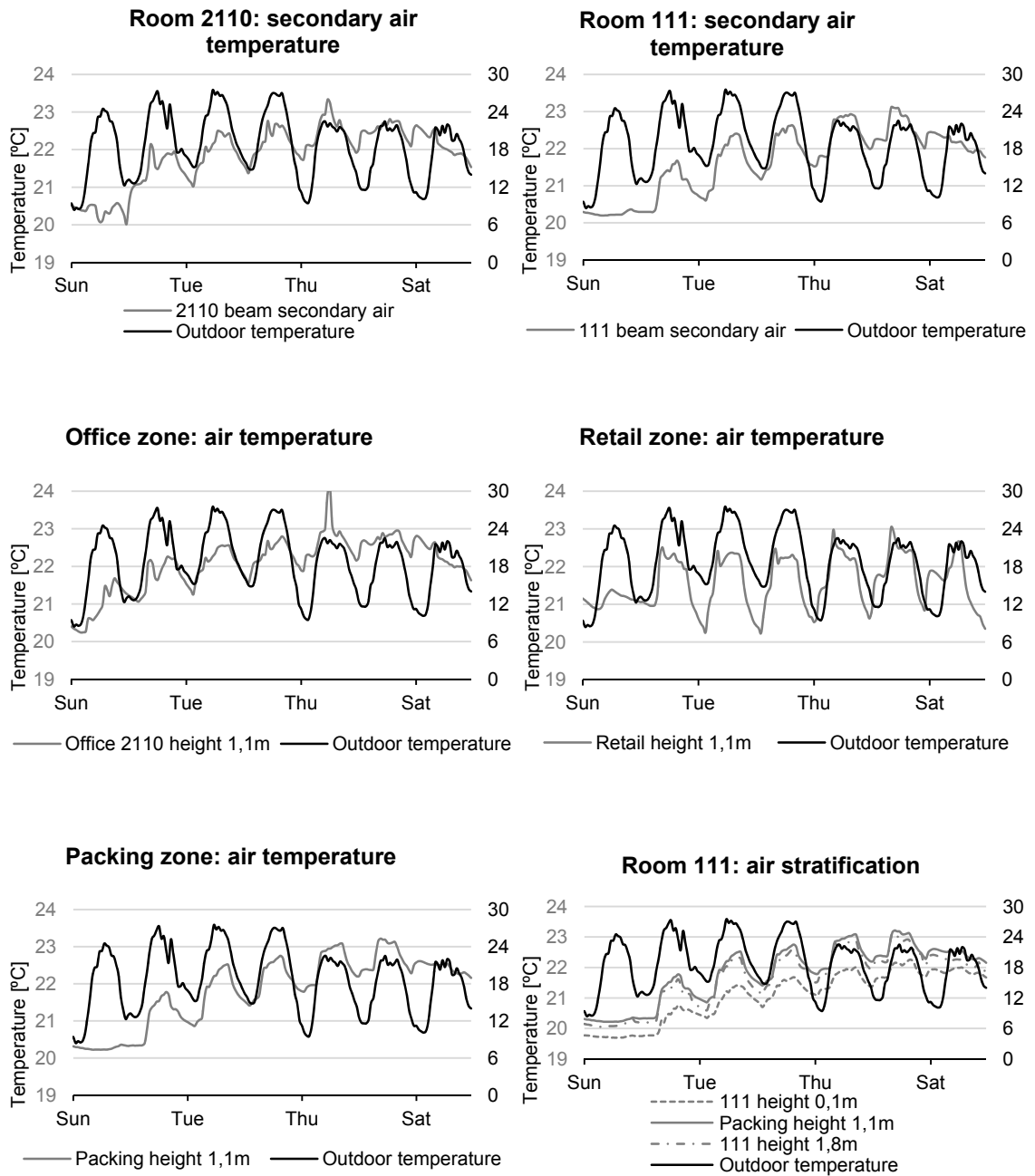

Figure 81 - Temperature profiles for the week with daily/weekly average maximum temperature and weekly maximum outdoor fluctuation (year 2012 - week 21)

Year 2012, Daily maximum outdoor fluctuation (Week 33)

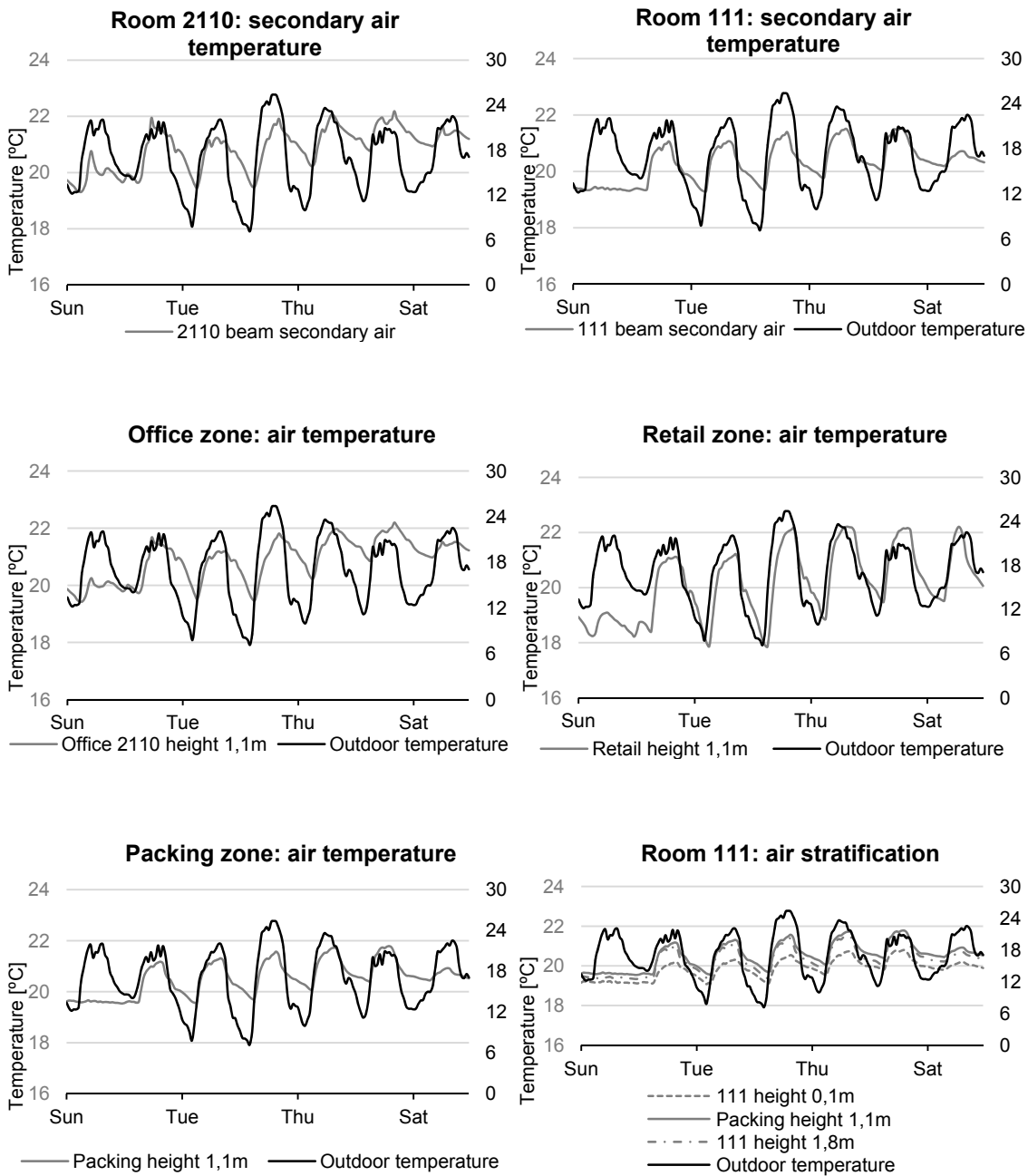

Figure 82 - Temperature profiles for the week with daily maximum outdoor temperature fluctuation (year 2012 week33)

Year 2012, Average Daily minimum temperature (Week 49)

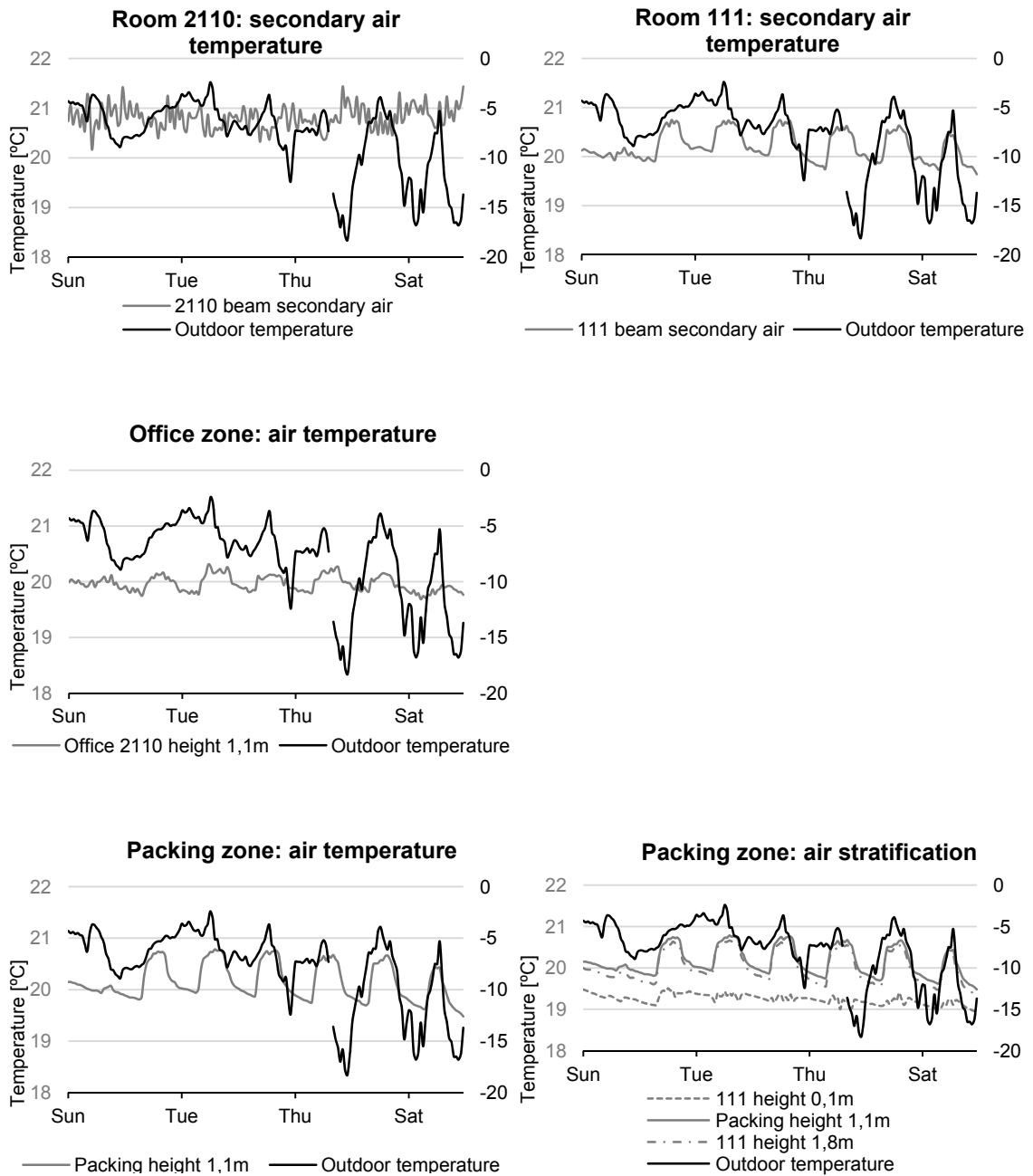

Figure 83 - Temperature profiles for the week with the daily minimum average outdoor temperature (year 2012 - week 49). Retail data are missing.

Visual Basic program for the evaluation of PPD and PMV

```

'-----
'-----
' Predicted Mean Vote (PMV) and Predicted Percentage of Dissatisfied
(PPD) in accordance with ISO 7730
'---- December 18 2002, edited by Takahiro SATO, Tanabe Lab., Waseda
Univ. ----
'-----
-----
Function FNPS(T)
FNPS = Exp(16.6536 - 4030.183 / (T + 235))           'Saturated Vapor
Pressure, [kPa]
End Function

Function PMV(Ta, Tr, Vel, RH, CLO, MET, EW)         'Definition of the
Function "PMV" by 7 factors

' Ta : Air Temperature, [deg.C]
' @Tr @: Mean Radiant Temperature, @ [deg.C]
' @Vel : Relative Air Velocity, [m/s]
' RH : Relative Humidity, [%]
' CLO : Clothing, [clo]
' MET : Metabolic Rate, [met]

' EW : External Work, [met] (=normally around 0)
' PA : Water Vapor Pressure, [Pa]
Pa = RH * 10 * FNPS(Ta) '[Pa]=(RH/100)*1000*[kPa]

'---METABORIC RATE---
M = MET * 58.15: 'Metabolic Rate, [W/m2]
W = EW * 58.15: 'External Work, [W/m2]
MW = M - W 'internal heat production in the human body

'---CLOTHING---
Icl = 0.155 * CLO: 'thermal insulation of the Clothing, [m2K/W]
If Icl < 0.078 Then fcl = 1 + 1.29 * Icl Else fcl = 1.05 + 0.645 * Icl
'clothing area factor

'---CONVECTION---
HCF = 12.1 * Sqr(Vel): 'convective heat transfer coefficient by forced
convection
TaA = Ta + 273: 'Air Temperature in Kelvin [K]
TrA = Tr + 273: 'Mean Radiant Temperature in Kelvin [K]

'CALCULATE SURFACE TEMPERATURE OF CLOTHING BY ITERATION
TCLA = TaA + (35.5 - Ta) / (3.5 * (6.45 * Icl + 0.1))
'first guess for surface temperature of clothing
P1 = Icl * fcl: 'calculation term
P2 = P1 * 3.96: 'calculation term
P3 = P1 * 100: 'calculation term
P4 = P1 * TaA: 'calculation term
P5 = 308.7 - 0.028 * MW + P2 * (TrA / 100) ^ 4 'calculation term
XN = TCLA / 100
XF = XN
N = 0: 'N: number of iterations
EPS = 0.00015: 'stop criteria in iteration

Do
XF = (XF + XN) / 2

```

```

'convective heat Transf. coeff. by natural convection
HCN = 2.38 * Abs(100 * XF - TaA) ^ 0.25
If HCF > HCN Then hc = HCF Else hc = HCN
XN = (P5 + P4 * hc - P2 * XF ^ 4) / (100 + P3 * hc)
N = N + 1

If N > 150 Then GoTo 50
Loop Until Abs(XN - XF) < EPS

Tcl = 100 * XN - 273: 'surface temperature of the clothing

'---HEAT LOSS COMPONENTS---
'heat loss diff. through skin
Ediff = 3.05 * 0.001 * (5733 - 6.99 * MW - Pa)
'heat loss by sweating (comfort)
If MW > 58.15 Then Esw = 0.42 * (MW - 58.15) Else Esw = 0!
'latent respiration heat loss
LRES = 1.7 * 0.00001 * M * (5867 - Pa)
'dry respiration heat loss
DRES = 0.0014 * M * (34 - Ta)
'heat loss by radiation
R = 3.96 * fcl * (XN ^ 4 - (TrA / 100) ^ 4)
'heat loss by convection
C = fcl * hc * (Tcl - Ta)

'--- CALCULATE PMV AND PPD ---
'Thermal sensation transfer coefficient
TS = 0.303 * Exp(-0.036 * M) + 0.028

'Predicted Mean Vote
PMV = TS * (MW - Ediff - Esw - LRES - DRES - R - C)

GoTo 80
50 PMV = 999999!
80 '
End Function

'Predicted PercentAge of Dissatisfied
Function PPD(PMV)
PPD = 100 - 95 * Exp(-0.03353 * PMV ^ 4 - 0.2197 * PMV ^ 2)
End Function

```

Figure 84 - Visual Basic Software for the calculation of PPD and PMV according with Standard ISO 7730

Winter and summer energy classification and detailed data concentration

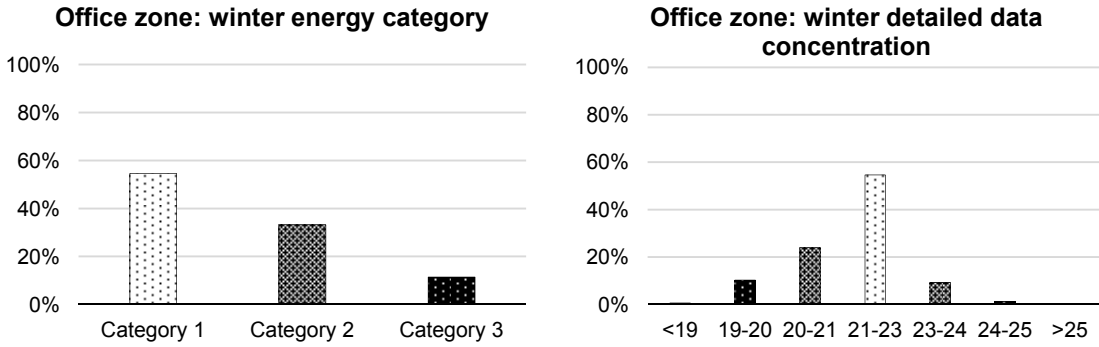

Figure 85 - Office zone: winter energy classification following standard EN 15251

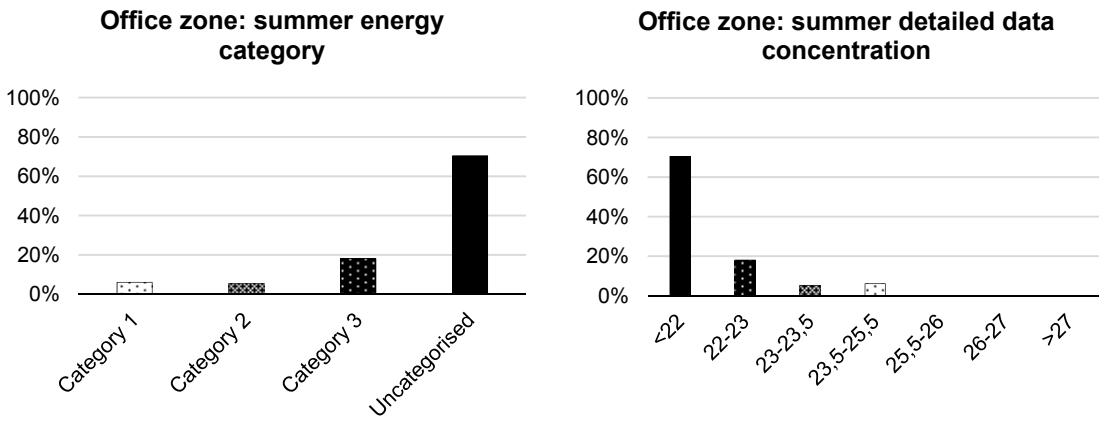

Figure 86 - Office zone: summer energy classification following standard EN 15251

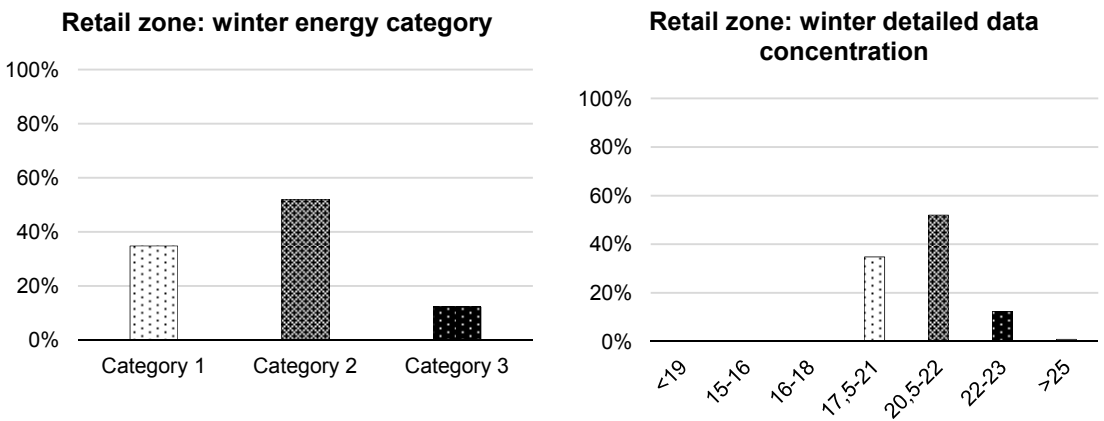

Figure 87 - Retail zone: winter energy classification following standard EN 15251

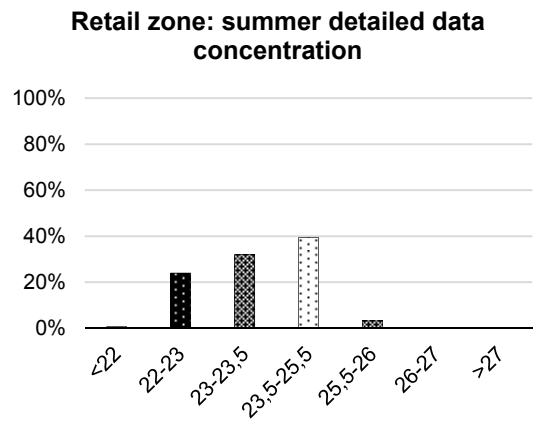
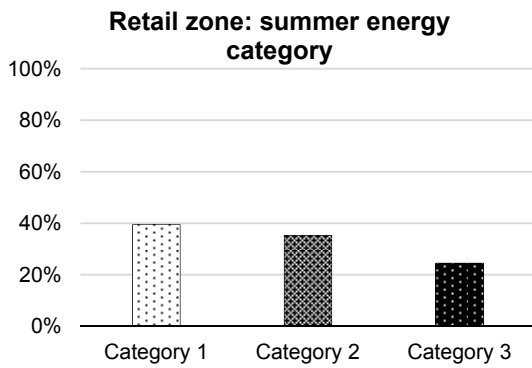

Figure 88 - Retail zone: summer energy classification following standard EN 15251

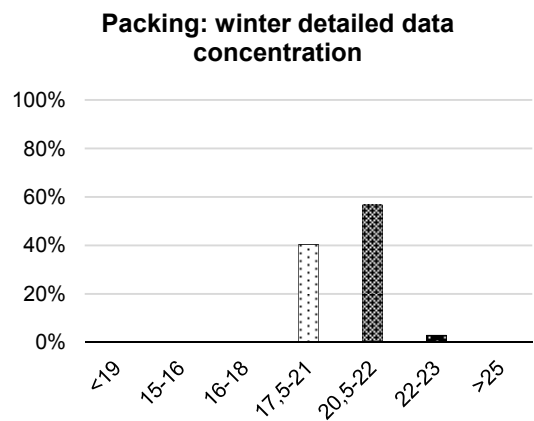
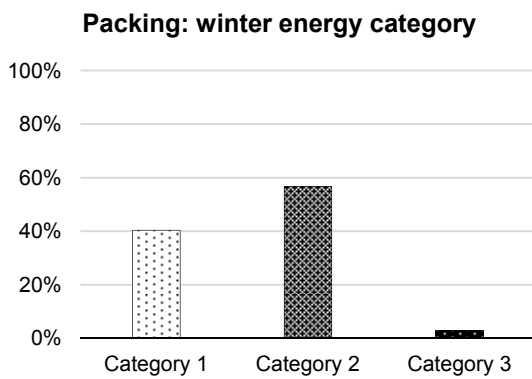

Figure 89 - Packing zone: winter energy classification following standard EN 15251

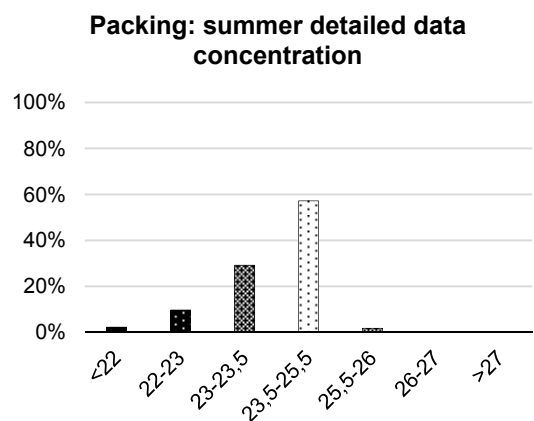
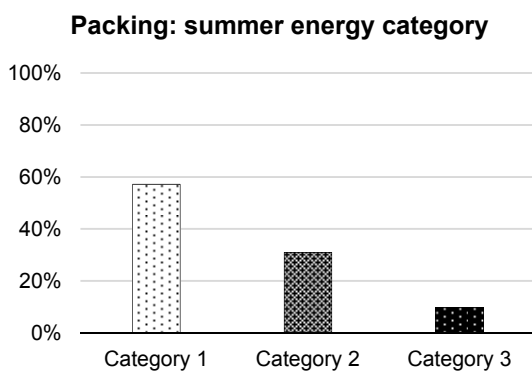

Figure 90 - Packing zone: summer energy classification following standard EN 15251

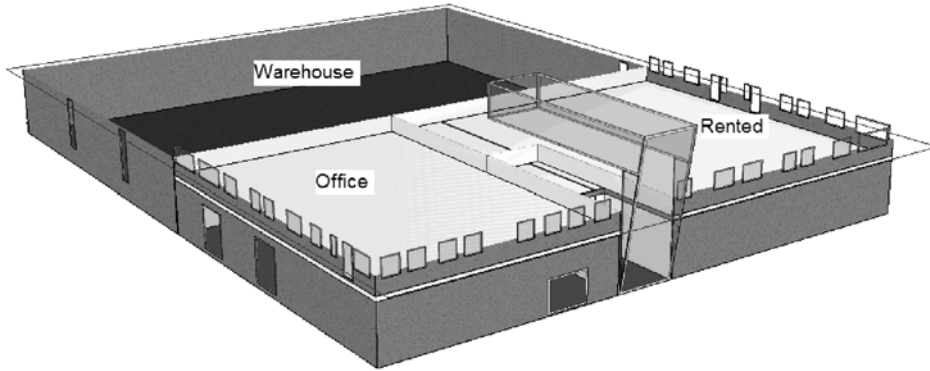

Figure 91 - First floor sketch from IDA ICE

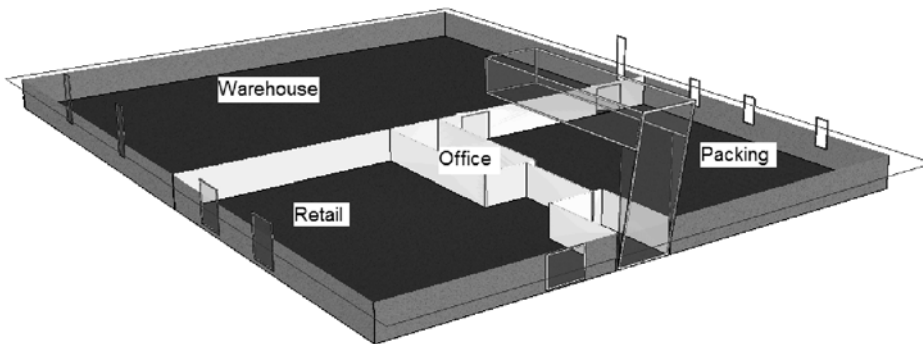

Figure 92 - Ground floor sketch from IDA ICE

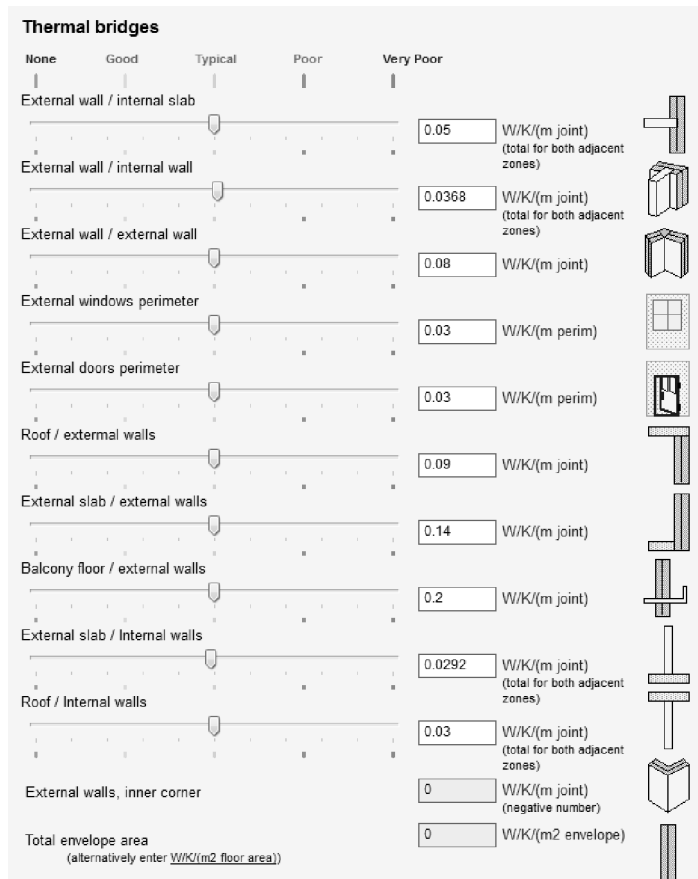

Figure 93 - List of thermal Bridges

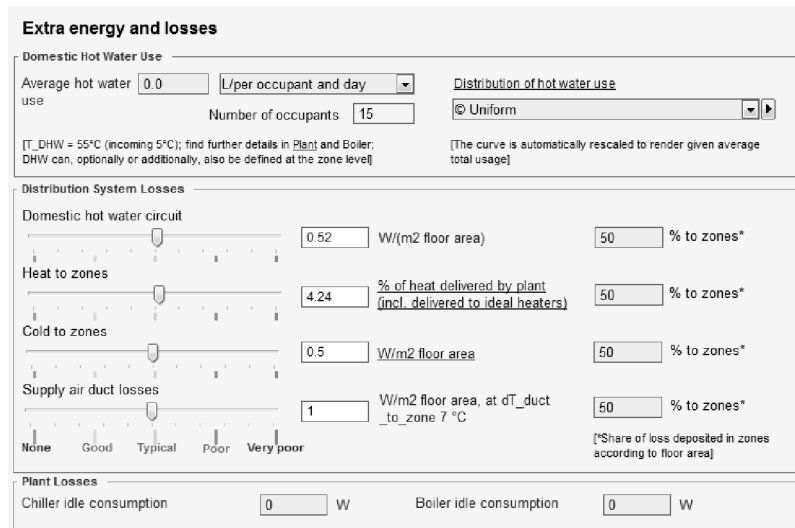

Figure 94 - Extra energy and losses

IDA ICE temperature output for the model based on the RYR (Torup A, weather station data)

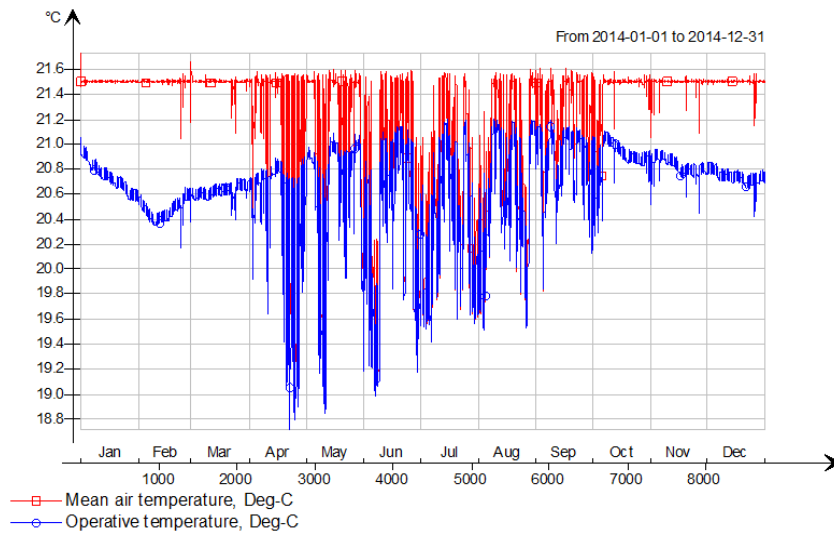

Figure 95 - IDA ICE output: ground floor office temperature profile

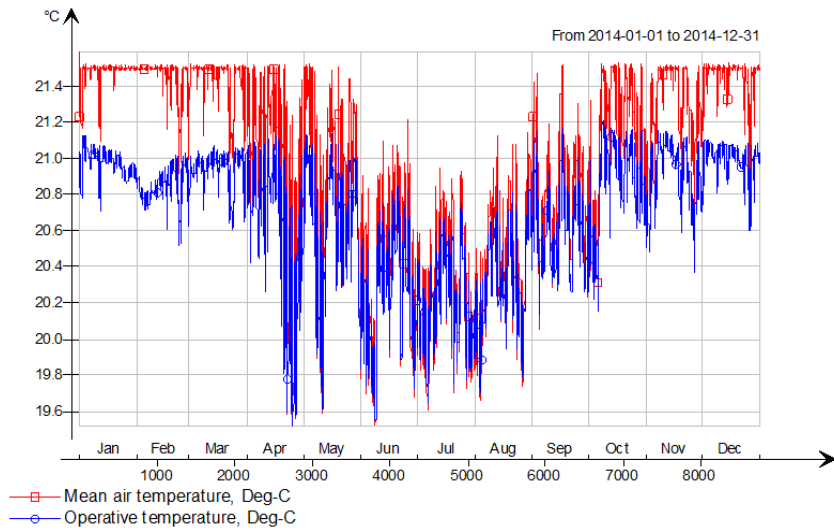

Figure 96 - IDA ICE output: first floor office temperature profile

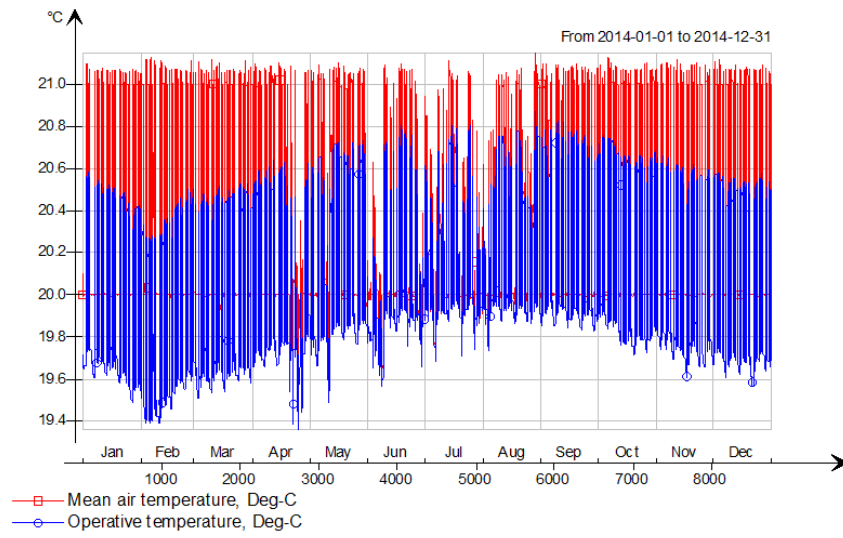

Figure 97 - IDA ICE output: retail temperature profile

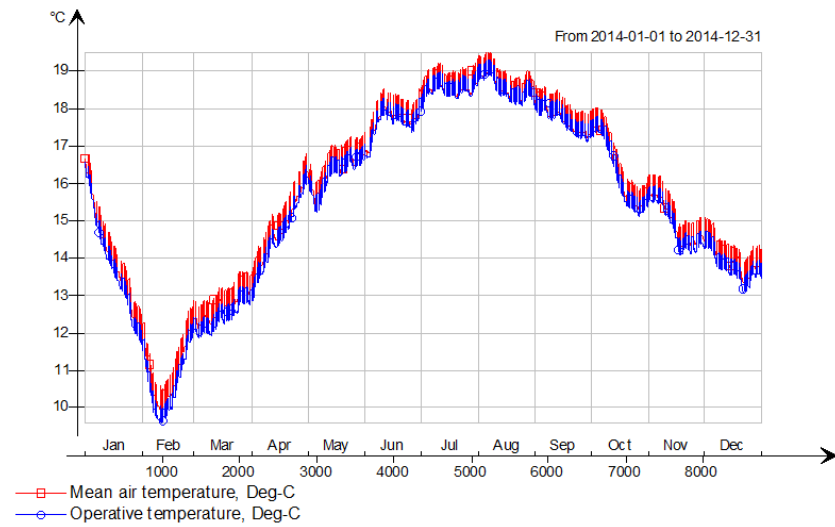

Figure 98 - IDA ICE output: packing temperature profile

Table 47 - Energy consumption in three functioning methods

	CAV [kWh _e]	CAV + Nightmode [kWh _e]	DCV [kWh _e]
Offices			
Jan	1880,41	1334,79	926,73
Feb	1666,16	1155,49	799,20
Mar	1606,56	1103,99	710,31
Apr	1305,30	847,36	452,77
May	1111,66	765,81	351,06
Jun	1064,03	751,71	370,05
Jul	1068,16	844,66	493,29
Aug	1059,93	802,45	423,60
Sep	1172,09	793,72	387,78
Oct	1370,93	927,71	526,03
Nov	1658,74	1114,77	711,58
Dec	1851,99	1323,10	931,23
Retail			
Jan	1482,15	1133,99	708,16
Feb	1330,31	1004,29	624,14
Mar	1260,98	975,85	557,37
Apr	1061,58	868,29	423,17
May	984,00	897,97	364,10
Jun	1047,63	942,82	367,70
Jul	1100,30	1055,90	442,70
Aug	1092,38	1013,47	412,01
Sep	1046,86	941,47	408,16
Oct	1139,48	986,28	500,50
Nov	1279,45	965,71	551,38
Dec	1471,10	1142,45	722,97
Packing			
Jan	1371,45	1057,98	838,06
Feb	1267,10	977,79	786,99
Mar	1190,60	911,29	699,39
Apr	896,88	684,37	453,57
May	660,35	571,40	292,19
Jun	569,11	498,61	196,80
Jul	553,89	525,97	231,71
Aug	571,94	522,58	215,18
Sep	704,06	590,63	304,76
Oct	909,27	728,94	474,27
Nov	1174,41	868,63	653,85
Dec	1389,64	1091,88	882,85

Energy evaluation based on the collected data

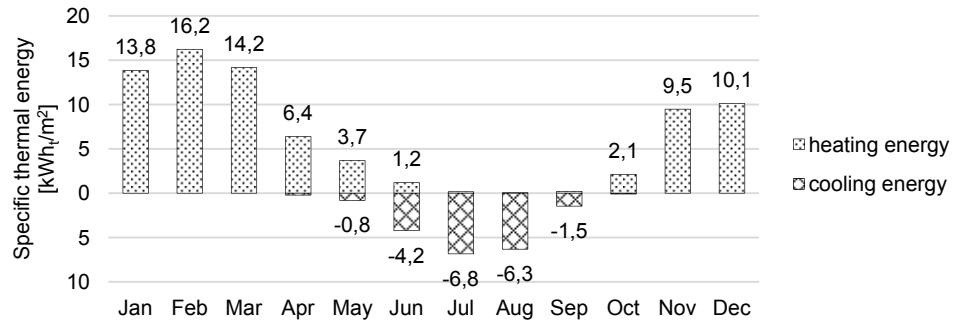

Figure 99 – Office zone: Thermal energy for heating and cooling estimated on recorded data

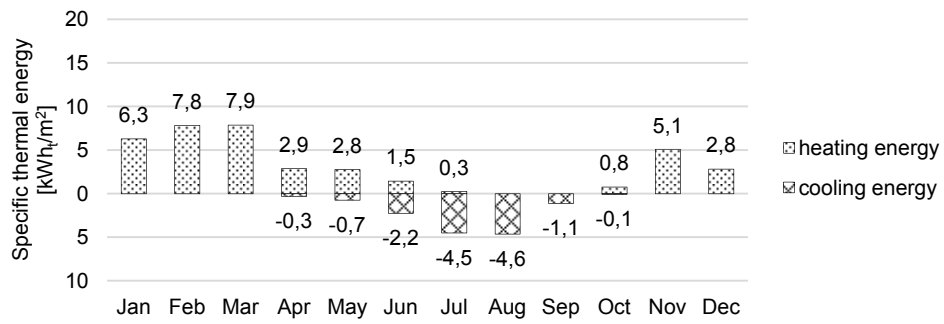

Figure 100 – Retail zone: Thermal energy for heating and cooling estimated on recorded data

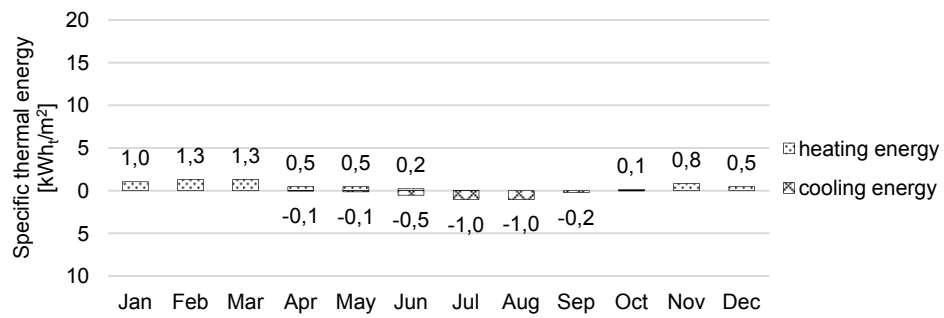

Figure 101 - Packing zone: Thermal energy for heating and cooling estimated on recorded data

Table 48 - Office zone comparison between analysis on recorded data and model on Ida Ice

	Energy analysis [kWh/m ²]	Torup A weather data model [kWh/m ²]	Percentage gap between model and energy analysis
Jan	4,64	4,61	1%
Feb	5,05	5,33	-6%
Mar	4,83	4,53	6%
Apr	3,25	3,19	2%
May	2,93	3,02	-3%
Jun	3,29	2,51	24%
Jul	3,73	2,45	34%
Aug	3,69	2,50	32%
Sep	2,41	2,66	-10%
Oct	2,25	3,29	-47%
Nov	3,03	3,60	-19%
Dec	3,88	4,14	-7%
Average			0,6%

Table 49 - Retail zone, comparison between analysis on recorded data and model on IDA ICE

	Energy analysis [kWh/m ²]	Torup A weather data model [kWh/m ²]	Percentage gap between model and energy analysis
Jan	3,72	3,99	-7%
Feb	3,93	4,89	-24%
Mar	4,22	3,86	8%
Apr	3,23	3,02	6%
May	3,44	2,96	14%
Jun	3,53	2,88	19%
Jul	3,83	3,09	19%
Aug	3,99	2,95	26%
Sep	2,99	2,80	7%
Oct	2,60	3,00	-15%
Nov	2,52	3,08	-22%
Dec	3,02	3,53	-17%
Average			1,1%

Table 50 - Packing zone, comparison between analysis on recorded data and model on IDA ICE

	Energy analysis [kWh/m ²]	Torup A weather data model [kWh/m ²]	Percentage gap between model and energy analysis
Jan	0,62	0,39	37%
Feb	0,65	0,50	23%
Mar	0,70	0,36	48%
Apr	0,54	0,31	43%
May	0,57	0,33	43%
Jun	0,62	0,36	42%
Jul	0,71	0,41	42%
Aug	0,73	0,38	48%
Sep	0,51	0,33	35%
Oct	0,43	0,32	27%
Nov	0,41	0,30	27%
Dec	0,50	0,33	33%
Average			37,3%

Table 51 - Comparison on the energy demand for two different locations (based on IWEC2 data)

	Ängelholm [kWh/m ²]	Gothenburg [kWh/m ²]	Percentage gap between model and energy analysis
Jan	8,25	8,72	-6%
Feb	7,51	8,00	-7%
Mar	7,13	7,57	-6%
Apr	5,72	6,07	-6%
May	5,07	5,06	0%
Jun	5,25	4,87	7%
Jul	5,47	5,34	2%
Aug	5,37	5,47	-2%
Sep	5,31	5,06	5%
Oct	5,99	6,00	0%
Nov	7,14	6,94	3%
Dec	8,27	8,22	1%
Average			-1%

Simulation results

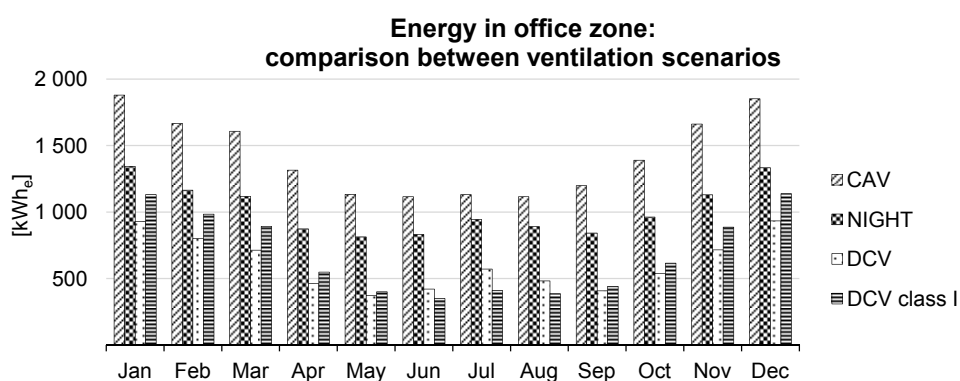

Figure 102 – Office zone: monthly amount of energy for different simulated scenarios

Table 52 – Office zone: detailed monthly percentage of energy reduction in the simulated scenarios

	Jan	Feb	Mar	Apr	May	Jun	Jul	Aug	Sep	Oct	Nov	Dec	Annual average
CAV → VAV	28%	30%	30%	34%	28%	25%	16%	20%	30%	31%	32%	28%	28%
VAV → DCV	31%	31%	36%	47%	54%	49%	39%	46%	52%	44%	37%	30%	40%
CAV → DCV	51%	52%	56%	65%	67%	62%	49%	57%	66%	61%	57%	50%	57%
DCV → DCV class I	-22%	-23%	-25%	-19%	-7%	17%	28%	20%	-8%	-14%	-24%	-22%	-11%

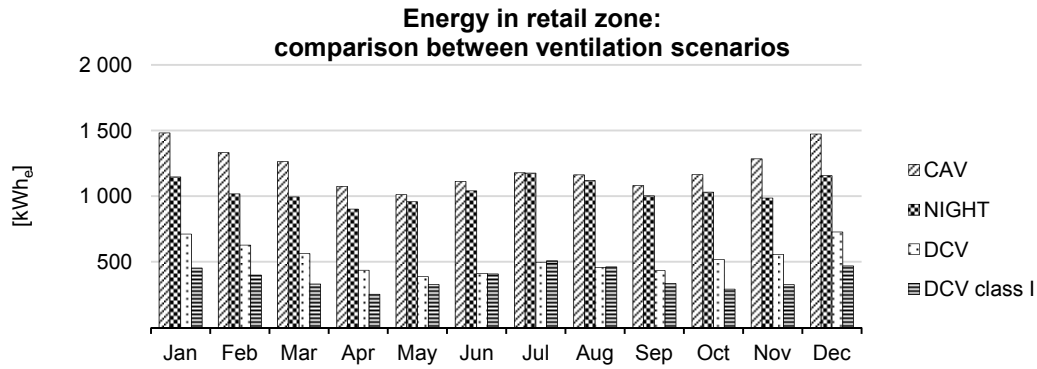

Figure 103 - Retail zone: monthly amount of energy for different simulated scenarios

Table 53 – Retail zone: detailed monthly percentage of energy reduction in simulated scenarios

	Jan	Feb	Mar	Apr	May	Jun	Jul	Aug	Sep	Oct	Nov	Dec	Annual average
CAV → VAV	23%	24%	21%	16%	5%	7%	0%	4%	7%	11%	23%	22%	14%
VAV → DCV	38%	38%	43%	52%	60%	61%	58%	59%	57%	50%	43%	37%	50%
CAV → DCV	52%	53%	55%	59%	62%	63%	58%	61%	60%	56%	57%	51%	57%
DCV → DCV class I	36%	36%	41%	42%	15%	1%	-2%	-1%	23%	44%	41%	35%	28%

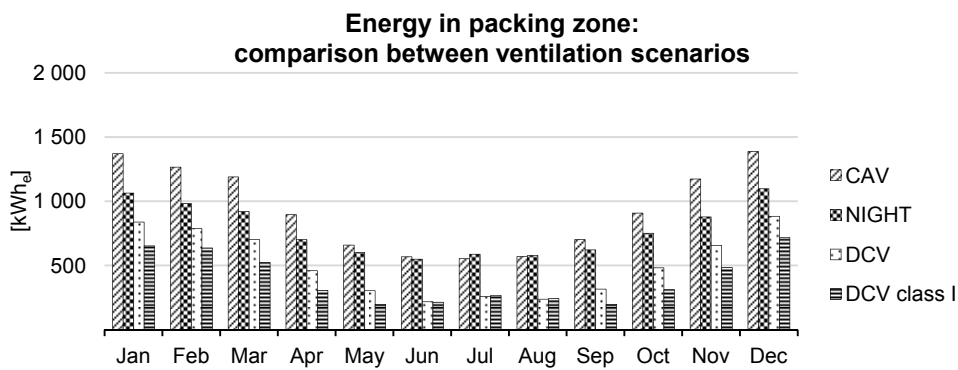

Figure 104 – Packing zone: monthly amount of energy for different simulated scenarios

Table 54 – Packing zone: detailed monthly percentage of energy reduction in simulated scenarios

	Jan	Feb	Mar	Apr	May	Jun	Jul	Aug	Sep	Oct	Nov	Dec	Annual average
CAV → VAV	22%	22%	23%	22%	9%	3%	-6%	-1%	12%	17%	25%	21%	17%
VAV → DCV	21%	20%	24%	34%	50%	60%	56%	59%	49%	36%	25%	19%	34%
CAV → DCV	39%	38%	41%	49%	54%	62%	53%	58%	55%	47%	44%	36%	45%
DCV → DCV class I	22%	19%	25%	33%	35%	2%	-3%	-2%	37%	35%	26%	19%	23%

Office zone

System improving scenario CAV → DCV

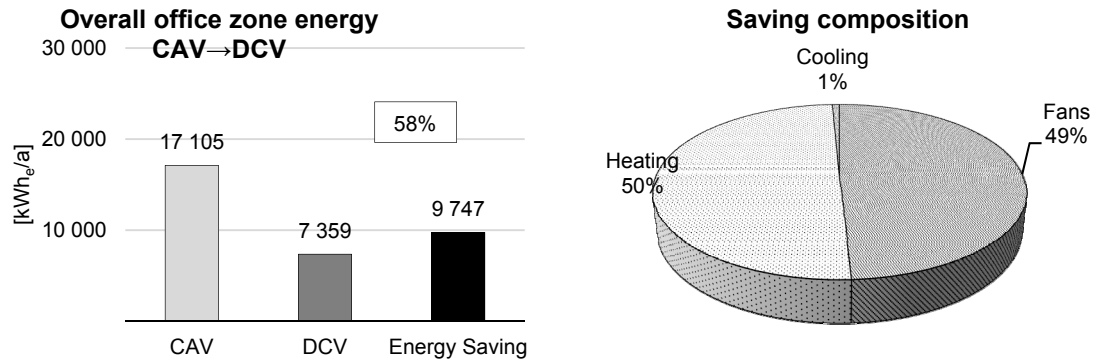

Figure 105 - Office zone: overall energy and composition of the saving in scenario CAV → DCV

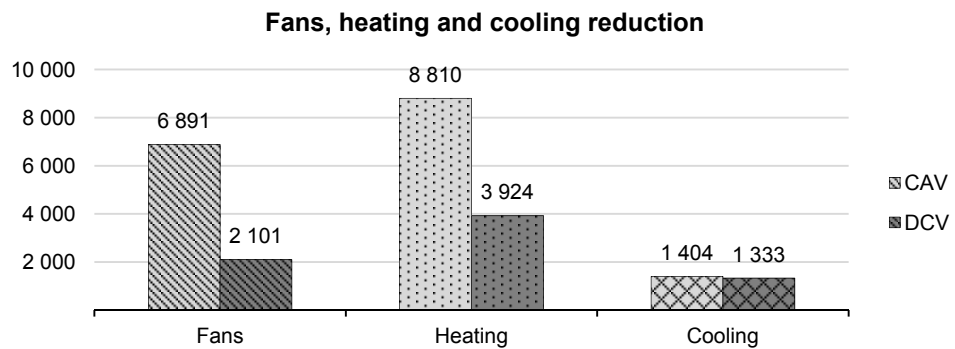

Figure 106 - Office zone: detailed energy reduction in scenario CAV → DCV

Table 55 - Office zone: energy consumption and reduction in scenario CAV → DCV

Scenario	Overall consumption [kWh _e /a]	Fans [kWh _e /a]	Heating [kWh _e /a]	Cooling [kWh _e /a]
CAV	17 105	6 891	8 810	1 404
DCV	7 359	2 101	3 924	1 333
	[kWh _e /a]	9 747	4 790	71
Saving	[%]	57%	69,5%	5%

System improvement scenario VAV → DCV

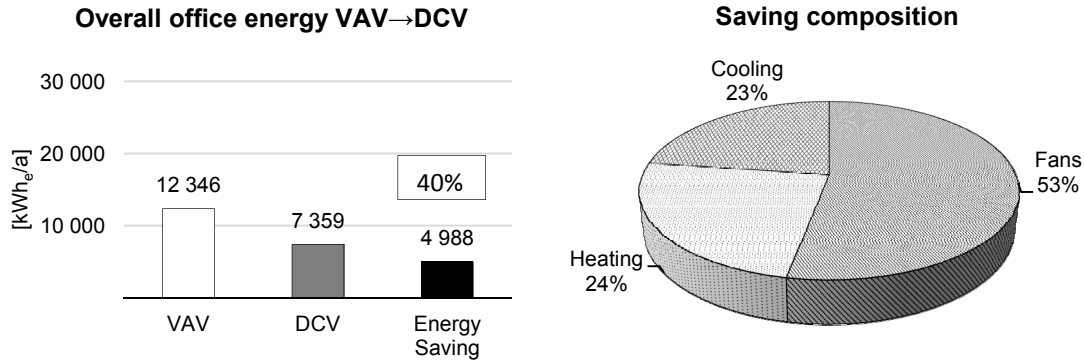

Figure 107 - Office zone: overall energy and composition of the saving in scenario VAV → DCV

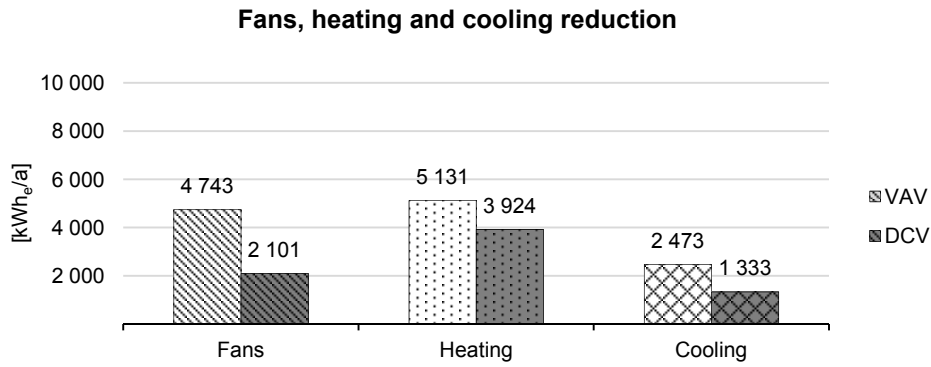

Figure 108 - Office zone: detailed energy reduction in scenario VAV → DCV

Table 56 Office zone: energy consumption and reduction in scenario VAV → DCV

Scenario		Overall consumption [kWh _e /a]	Fans [kWh _e /a]	Heating [kWh _e /a]	Cooling [kWh _e /a]
VAV		12 346	4 743	5 131	2 473
DCV		7 359	2 101	3 924	1 333
	[kWh _e /a]	4 987	2 642	1 207	1 140
Saving	[%]	40,4%	55,7%	23,5%	46,1%

System improvement scenario DCV → DCV class I

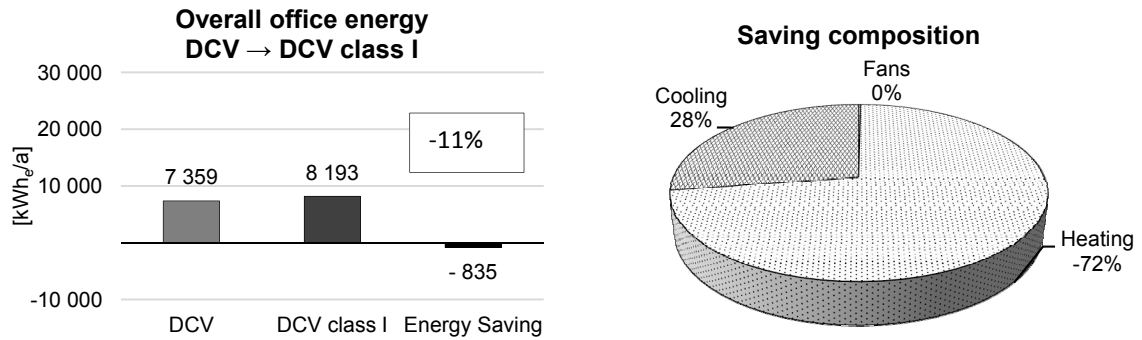

Figure 109 - Office zone: overall energy and composition of the saving in scenario DCV → DCV class I

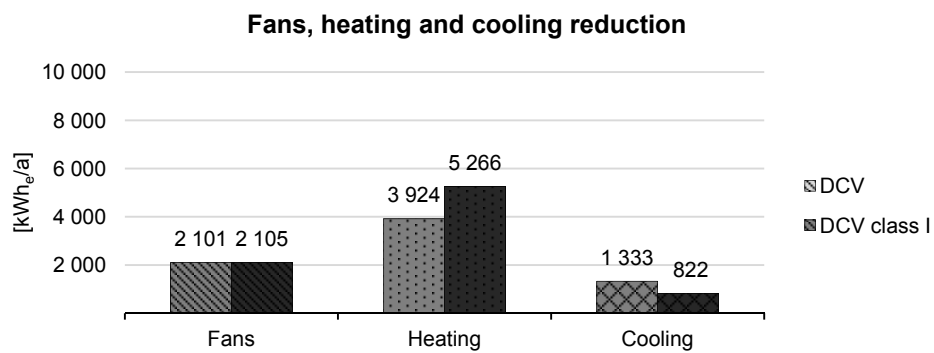

Figure 110 - Office zone: detailed energy reduction in scenario DCV → DCV class I

Table 57 - Office zone: energy consumption and reduction in scenario DCV → DCV class I

Scenario	Overall consumption [kWh _e /a]	Fans [kWh _e /a]	Heating [kWh _e /a]	Cooling [kWh _e /a]	
DCV	7 359	2 101	3 924	1 333	
DCV class I	8 193	2 105	5 266	822	
	[kWh _e /a]	-835	-4	-1342	511
Saving	[%]	-11,3%	0%	34,2%	38,3%

Retail zone

System improvement scenario CAV → DCV

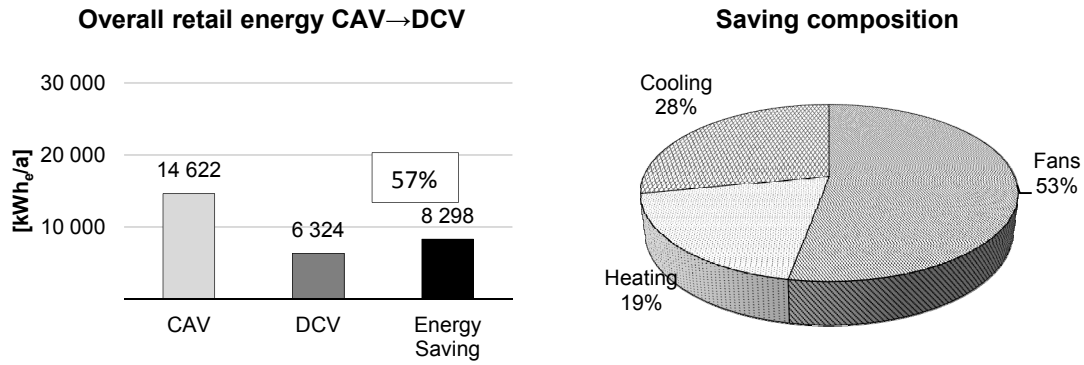

Figure 111 - Retail zone: overall energy and composition of the saving in scenario CAV → DCV

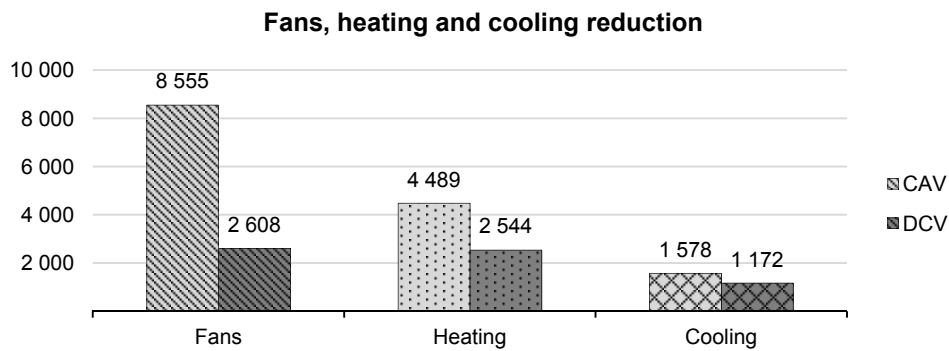

Figure 112 - Retail zone: detailed energy reduction in scenario CAV → DCV

Table 58 - Retail zone: energy consumption and reduction in scenario CAV → DCV

Scenario		Overall consumption [kWh _e /a]	Fans [kWh _e /a]	Heating [kWh _e /a]	Cooling [kWh _e /a]
CAV		14 622	8 555	4 489	1 578
DCV		6 342	2 608	2 544	1 172
	[kWh _e /a]	8 280	5 947	1 945	406
Saving	[%]	56,6%	69,5%	43,3%	25,7%

System improvement scenario VAV → DCV

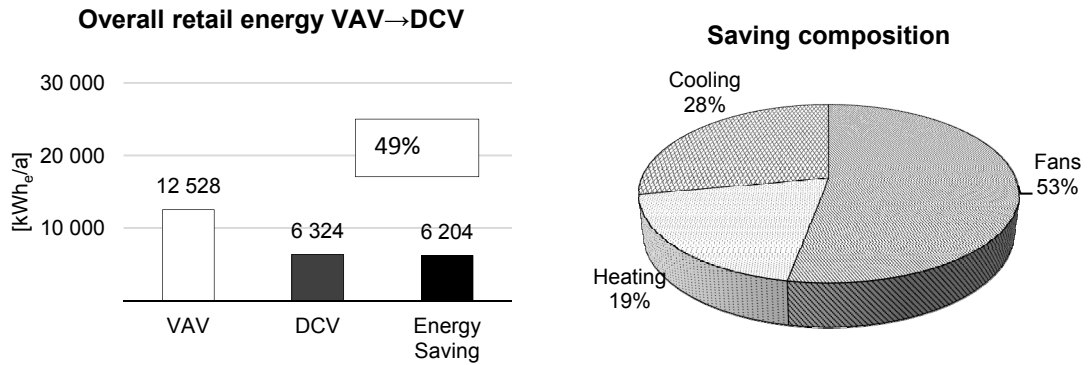

Figure 113 - Retail zone: overall energy and composition of the saving in scenario VAV → DCV

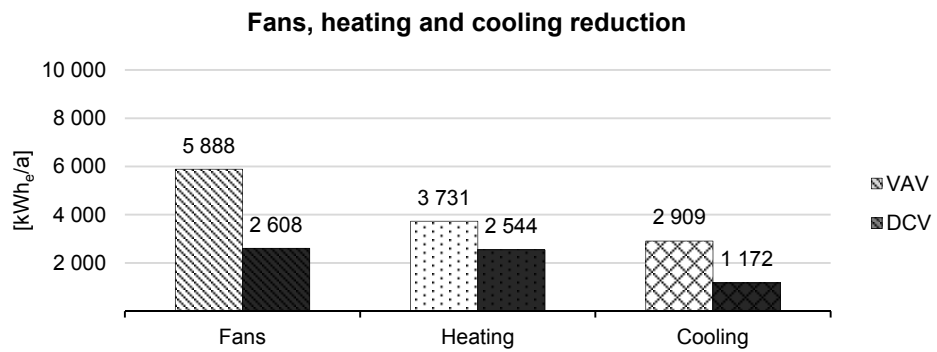

Figure 114 - Retail zone: detailed energy reduction in scenario VAV → DCV

Table 59 - Retail zone: energy consumption and reduction in scenario VAV → DCV

Scenario	Overall consumption [kWh _e /a]	Fans [kWh _e /a]	Heating [kWh _e /a]	Cooling [kWh _e /a]
VAV	12 528	5 888	3 731	2 909
DCV	6 324	2 608	2 544	1 172
	[kWh _e /a]	6 204	3 279	1 188
Saving	[%]	49,5%	55,7%	31,8%
			1 737	59,7%

System improvement scenario DCV → DCV class I

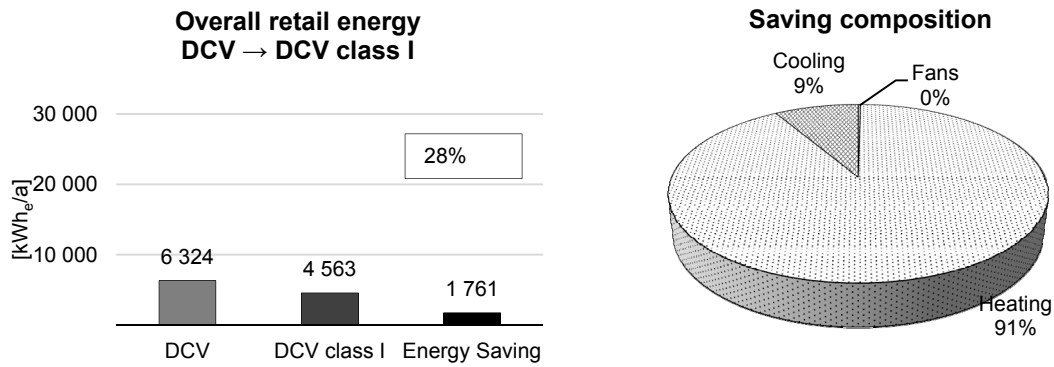

Figure 115 - Retail zone: overall energy and composition of the saving in scenario DCV → DCV class I

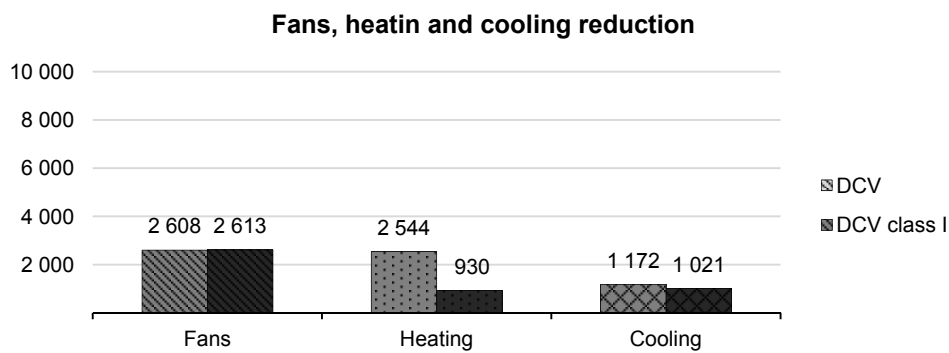

Figure 116 - Retail zone: detailed energy reduction in scenario DCV → DCV class I

Table 60 - Retail zone: energy consumption and reduction in scenario DCV → DCV class I

Scenario	Overall consumption [kWh _e /a]	Fans [kWh _e /a]	Heating [kWh _e /a]	Cooling [kWh _e /a]
DCV	6 324	2 608	2 544	1 172
DCV class I	4 563	2 613	930	1 021
Saving	[kWh _e /a]	-5	1 614	151
	[%]	27,8%	0%	12,8%

Packing zone

System improvement scenario CAV → DCV

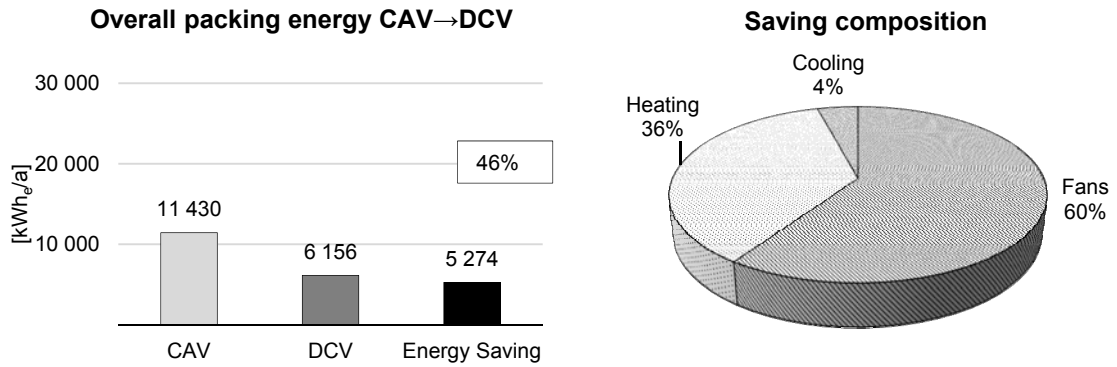

Figure 117 - Packing zone: overall energy and composition of the saving in scenario CAV → DCV

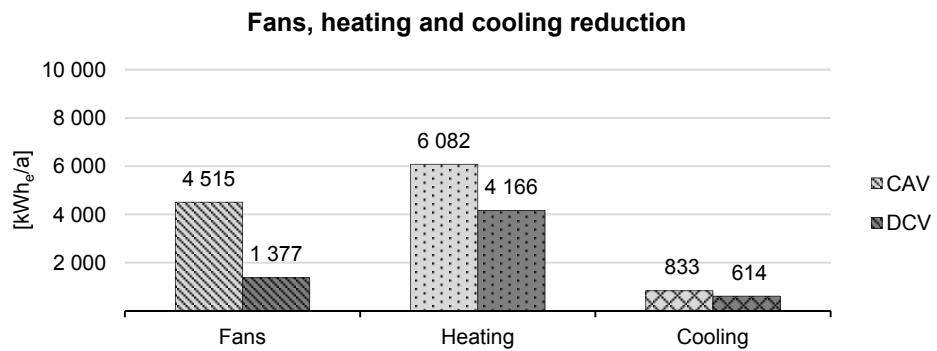

Figure 118 - Packing zone: detailed energy reduction in scenario CAV → DCV

Table 61 - Packing zone: energy consumption and reduction in scenario CAV → DCV

Scenario	Overall consumption [kWh _e /a]	Fans [kWh _e /a]	Heating [kWh _e /a]	Cooling [kWh _e /a]
CAV	11 430	4 515	6 082	833
DCV	6 156	1 377	4 166	614
	[kWh _e /a]	5 274	3 183	1 916
Saving	[%]	46,1%	70,5%	31,5%
			26,3%	

System improvement scenario VAV → DCV

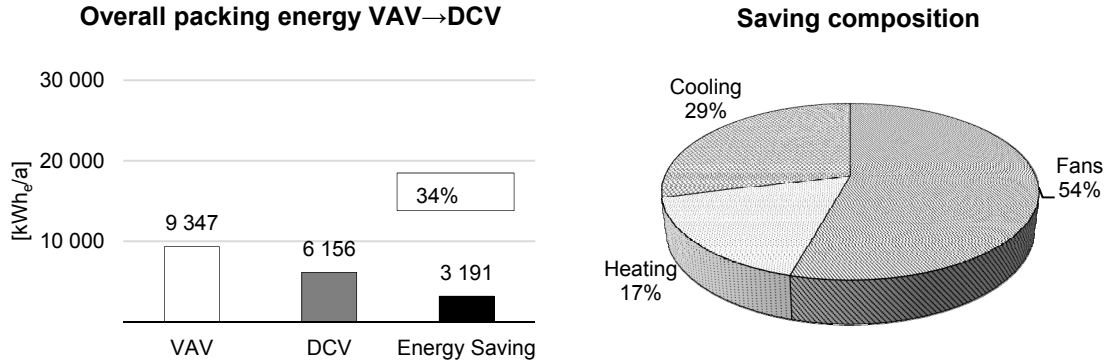

Figure 119 - Packing zone: overall energy and composition of the saving in scenario VAV → DCV

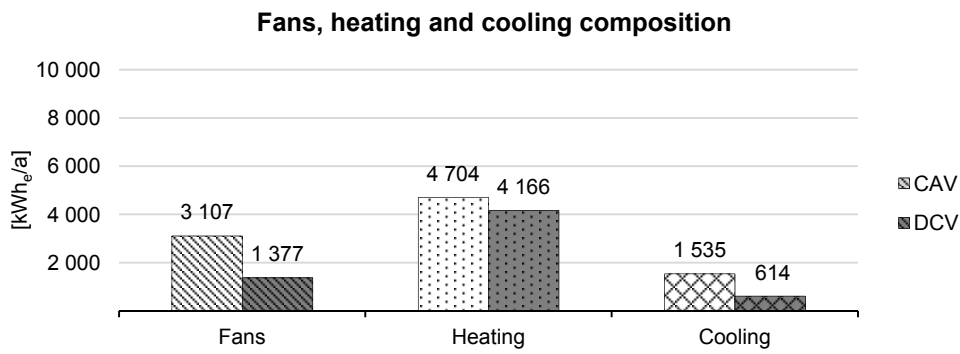

Figure 120 - Packing zone: detailed energy reduction in scenario VAV → DCV

Table 62 - Packing zone: energy consumption and reduction in scenario VAV → DCV

Scenario	Overall consumption [kWh _e /a]	Fans [kWh _e /a]	Heating [kWh _e /a]	Cooling [kWh _e /a]
VAV	9 347	3 107	4 704	1 535
DCV	6 156	1 377	4 166	614
Saving	3 191	1 730	538	921
	34,1%	55,7%	11,4%	60%

System improvement scenario DCV → DCV class I

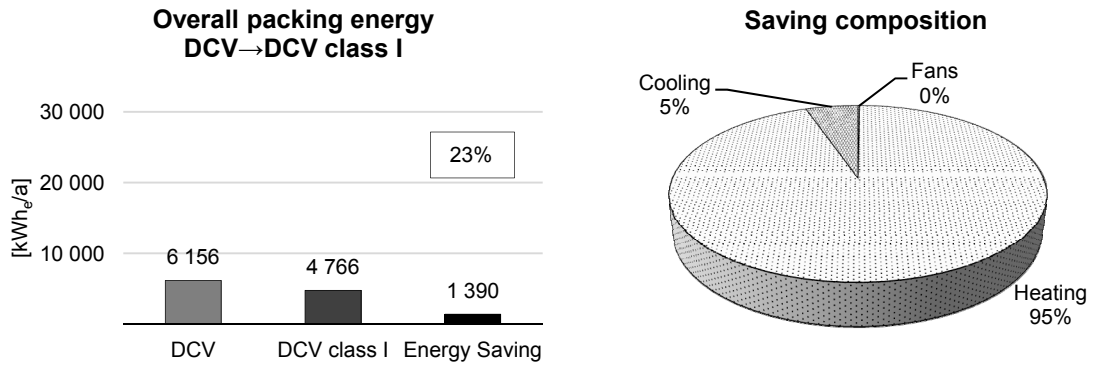

Figure 121 - Packing zone: overall energy and composition of the saving in scenario DCV → DCV class I

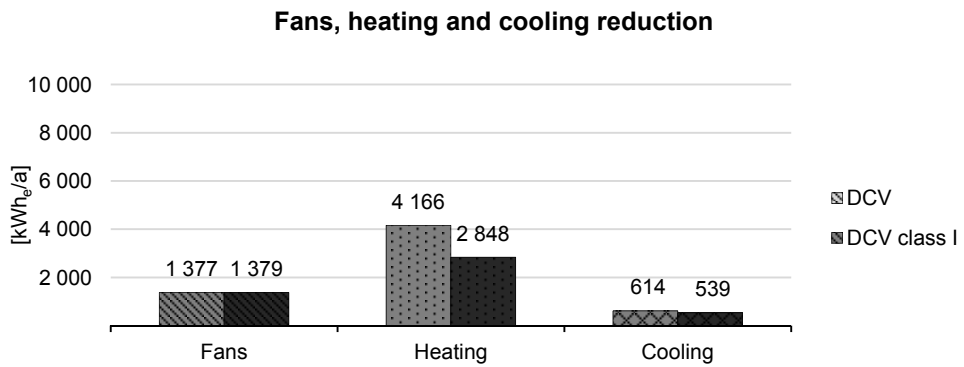

Figure 122 - Packing zone: detailed energy reduction in scenario DCV → DCV class I

Table 63 - Packing zone: energy consumption and reduction in scenario DCV → DCV class I

Scenario	Overall consumption [kWh _e /a]	Fans [kWh _e /a]	Heating [kWh _e /a]	Cooling [kWh _e /a]
DCV	6 156	1 377	4 166	614
DCV class I	4 766	1 379	2 848	539
[kWh _e /a]	1 390	-2	1 318	75
Saving [%]	22,6%	0%	31,6%	12,2%

Table 64 - Real installation: Operating cost [SEK/a]

	Operating cost [SEK/a]			
	Overall	Ventilation	Heating	Cooling
CAV	51 703	23 913	23 219	4 571
VAV	40 997	16 458	16 252	8 287
DCV	23 767	7 291	12 739	3 737
DCV Class I	20 992	7 304	10 835	2 853

Table 65 - Scenario (DH-CH): Operating cost [SEK/a]

	Operating cost [SEK/a]			
	Overall	Ventilation	Heating	Cooling
CAV	144 887	23 913	115 559	5 415
VAV	95 259	16 458	68 983	9 817
DCV	70 717	7 291	58 999	4 426
DCV Class I	64 271	7 304	53 587	3 380

14 Bibliography

- Boverket. 2011. Boverket's Building Regulations, BBR19. s.l. : Boverket, 2011.
- businessdictionary. 2014. [Online] <http://www.businessdictionary.com/definition/operating-cost.html>. Accessed 04/2014
- Chao, L. P and K. 2004. Project quality function deployment. *International Journal of Quality & Reliability Management*.
- De Carli, M. 2012. "Demand control ventilation (DCV)" Sistemi a volume d'aria variabile di ultima generazione. (Italian)
- De Carli, M. 2006. People's clothing behaviour according to external weather and indoor environment. *Building and Environment*.
- Efficiency Valuation Organization (EVO). 2002. *International Performance Measurement and Verification, Vol.1*. EVO.
- El-Haram, M. A. and Horner, M. W. 2003. Applications of principles of ILS to the development of cost effective maintenance strategies for existing building stock. *Construction Management and Economics*.
- El-Haram, M. A. and Horner, M. W. 2002. Development of a generic for collecting whole life cost data for the building industry. *Journal of Quality Maintenance Engineering*.
- EN 15251. 2007. Indoor environmental input parameters for design and assessment of energy performance of building- addressing indoor air quality, thermal environment, lighting and acoustic. European Committee for Standardisation.
- epp.eurostat.ec.europa.eu. 2014. epp.eurostat.ec.europa.eu. [Online]. http://epp.eurostat.ec.europa.eu/statistics_explained/index.php/Electricity_and_natural_gas_price_statistics. Accessed 04/2014
- EQUA. 2014. [Online]. <http://www.equa.se/index.php/en/ida-ice>. Accessed 05/2014
- falkenberg-energi. 2014. *falkenberg-energi*. [Online]. <http://www.falkenberg-energi.se/fjarrvarme/normalprislistor/falkenberg>. Accessed 04/2014
- feiertagskalender. 2011. *feiertagskalender*. [Online]. <http://www.feiertagskalender.ch/index.php?geo=3317&jahr=2011&hl=en>. Accessed 11/2013
- Google. 2014. Google. *Google*. [Online] https://www.google.se/search?q=%E2%82%AC+to+sek&ie=utf-8&oe=utf-8&aq=t&rls=org.mozilla:it:official&client=firefox-a&channel=fflb&gfe_rd=cr&ei=2j8rU_PsEI3K8gewg4HQBg. Accessed 20/03/2014.
- Google. 2013. Google Maps. [Online]. maps.google.com. Accessed 10/2013
- Industrial Ventilation - Design Guidebook*. Goodfellow, H. and Tähti, E. 2001. Academic press.
- Sveriges meteorologiska och hydrologiska institute. 2014. Sveriges meteorologiska och hydrologiska. [Online]. <http://opendata-download-metobs.smhi.se/explore/>. Accessed 01/2014
- investopedia. 2014. investopedia. [Online]. <http://www.investopedia.com/terms/p/paybackperiod.asp>. Accessed 03/2014
- iServcmb. 2014. [Online] 2014. <http://www.iservcmb.info/information>. Accessed 05/2014
- ISO 13370. 2007. Thermal performance of buildings - Heat transfer via the ground - Calculation methods. International Committee for Standardisation.

ISO 7730. 1994. *Ergonomia degli ambienti termici - Determinazione analitica e interpretazione del benessere termico mediante il calcolo degli indici PMV e PPD e dei criteri di benessere termico locale*. International Committee for Standardisation. (Italian)

Johansson, D. 2005. *Modelling Life Cycle Cost for Indoor Climate Systems*. Lund : Lund University.

Kalo, Markus T. 2013. DCV, Demand controlled ventilation, DCV for comfort and energy saving.

Nicol, J. F. and Humphreys, M. A. 2002. Adaptive thermal comfort and sustainable thermal standards for buildings. *Energy and Buildings*.

Nilsson, P.E. 2003. Achieving the desired indoor climate. *Studentlitteratur*. Lund University.

Olesen, B W. 2000. New developments in internal standards for the indoor thermal environment. Proceeding for Healthy Buildings.

Onset. 2013. [Online]. <http://www.onsetcomp.com/products/communications/zw-rcvr>. Accessed 11/2013

SketchUp, Google. 2013.

SMHI. 2014. [Online]. <http://opendata-download-metobs.smhi.se/explore/>. Accessed 01/2014

SMHI. 2014. Swedish solar map. *smhi*. [Online]. <http://strang.smhi.se/>. Accessed 01/2014

Sundell, J. and Kjellman, M. 1994. *Luften vi andas inomhus*. Stockholm : Folh lsoinstitutet.

Swegon. 2014. [Online]. <http://www.swegon.com/en/Resources/Software/ProSelect/>. Accessed 02/2014

UNI 8477. 1983. Energia solare. Calcolo degli apporti per applicazioni in edilizia. International Committee for Standardisation (Italian)

Bra ventilation. 2003. Bra ventilation. [Online] <http://www.svenskventilation.se/>. Accessed 12/2013

feiertagskalender [Online] 2011.

<http://www.feiertagskalender.ch/index.php?geo=3317&jahr=2011&hl=en>. Accessed 11/2013.

15 Symbols and abbreviations

Symbols		
\dot{m}_i	airflow for the single zone	[l/s]
\dot{m}_{tot}	overall airflow	[l/s]
$\dot{m}_{i,b}$	the airflow rate of the primary air for each beam b	[l/s]
\dot{m}_c	the ceiling airflow	[l/s]
$\bar{e}_{t,i}$	monthly demand of thermal energy	[kWh _t /m ²]
\dot{m}_{tot}	overall airflow	[l/s]
$\bar{e}_{el,f,i}$	specific monthly average fans energy	[kWh _e /m ²]
$e_{el,f,i}$	specific hourly average fans energy	[kWh _e /m ²]
$\bar{e}_{el,h}$	purchased energy used for the heating purpose	[kWh/m ²]
$\bar{e}_{el,c}$	purchased energy used for the cooling purpose	[kWh/m ²]
$p_{DH,v}$	variable price for district heating	[€/kWh _t]
$p_{DH,f}$	fix price for district heating	[€/a]
€	Euro	
ΔT	temperature difference	
AC_i	additional cost in the system improvement scenario i	[€]
AH	hourly angle	[°]
b	single beam	
COP_{HP}	COP for the installed heat pump	
c_p	specific heat for the air = 1005	[J/(kg·K)]
E_{el}	expected modelled annual consumption	[kWh _e /a]
$E_{el,c}$	partial expected consumption for cooling	[kWh _e /a]
$E_{el,h}$	partial expected consumption for heating	[kWh _e /a]
$E_{el,i}$	annual average specific electric energy	[kWh _e /(m ² ·a)]
$E_{el,v}$	partial expected consumption for ventilation	[kWh _e /a]
EER_{CH}	EER for the high efficiency air-water chiller	
EER_{HP}	EER for the installed heat pump	
$e_{t,i}$	hourly energy needed by the considered zone	[kWh _t]
f_{cl}	ratio of man surface area while clothed to man's surface while nude	
g-value	solar energy transmittance	[kWh/(m ² ·a)]
H_0	horizontal extra-atmospheric irradiance	[W/m ²]
h_c	convective heat transfer coefficient	[W/(m ² ·K)]
H_{diff}	diffuse irradiance on a horizontal surface on the ground	[W/m ²]
H_{glob}	global irradiance on a horizontal surface on the ground	[W/m ²]
HS	solar height angle	[°]
I_0	extra atmospheric irradiation on vertical surface	[W/m ²]
I_{cl}	thermal resistance of clothing	[W/m ²]
Lat.	latitude	[°]
Long.	longitude	[°]
M	metabolic rate	[W/m ²]
n	number of the day in the year	
OC	operating cost	[€/a]
OC_c	partial operating cost for cooling	[€/a]
OC_h	partial operating cost for heating	[€/a]
OC_v	partial operating cost for ventilation	[€/a]

p_a	partial vapour water pressure	[Pa]
PB	payback period	[y]
p_{el}	electric energy price	[€/kWh _e]
PMV	predicted mean vote	
PMV _L	predicted mean vote limit	
PPD	percentage of people dissatisfied	
PPD _L	percentage of people dissatisfied limit	
$Q_{f,el}$	electric capacity for fans	[kW]
Q_t	thermal capacity	[W]
$Q_{t,C}$	overall thermal capacity handled from the central AHU	[W]
$Q_{t,C,i}$	thermal capacity supplied to the single zone	[W]
$Q_{t,i}$	thermal capacity in the single zone i	[W]
$Q_{t,L,i}$	thermal capacity produced locally in the zone i	[W]
s	square foot each of the considered zone	[m ²]
SEK	Swedish crowns	
SFP	specific fan power	[kW/(m ³ /s)]
s_i	saving achieved with the system improvement scenario i	[€]
t_a	air temperature	[°C]
t_{cl}	surface temperature of clothing	[°C]
$t_{day,out}$	mean outdoor daily temperature	[°C]
t_i	temperature after the main coil	[°C]
t_{II}	temperature for the secondary air in the beams	[°C]
t_r	mean radiant temperature	[°C]
t_s	temperature supplied from the beam	[°C]
U_i	thermal transmittance	[W/(m ² ·K)]
U_{tot}	thermal transmittance	[W/(m ² ·K)]
U-value	thermal transmittance	[W/(m ² ·K)]
v_{ar}	air velocity relative to the human body	[°C]
w_f	weighting factors	
WT	weighted time	
δ	solar declination	[°]
Δt	temperature difference considered in the calculation	[°C]
ρ	density of the air at 20°C = 1,204	[kg/m ³]

Abbreviations

ACH	air changes per hour	
AHU	air handling unit	
AHUD	air handling unit data	
BMS	building management system	
CAV	constant air volume	
CAV_RYR	constant air volume model based on reference year on records	
CH	chiller	
CLO	clothing	
COP	coefficient of performance	
DCV	demand controlled ventilation	
DCV class I	demand controlled ventilation with the best indoor comfort conditions	
DH	district heating	
EER	energy efficiency ratio	
HP	heat pump	
HVAC	heating, ventilation and air conditioning	
IED	indoor environmental data	
IEQ	indoor environmental quality	
IWEC2	international weather for energy calculations	
Lat	latitude	[°]
Long	longitude	[°]
LPC	long period comfort	
MET	metabolic rate	
OC	operating costs	
PB	payback period	
PMV	predicted mean vote	
PPD	percentage of people dissatisfied	
RYR	reference year on records	
SFP	specific fan power	[kW/(m ³ ·s)]
SMHI	Swedish meteorological and hydrological institute	
TRY	test reference year	
VAV	variable air volume	
VOC	volatile organic compounds	